



# Vehicle History Report™

US \$44.99

## 2020 FORD FUSION HYBRID SE

VIN: 3FA6P0LU1LR195637  
SEDAN 4 DR  
2.0L I4 F DOHC 16V  
HYBRID  
FRONT WHEEL DRIVE  
Original Window Sticker

Branded Title: Salvage

8 Service history records

2 Previous owners

Types of owners: Commercial, Personal

Last owned in California

100,529 Last reported odometer reading

This CARFAX Vehicle History Report is based only on information supplied to CARFAX and available as of 2/5/26 at 8:16:26 AM (CST). Other information about this vehicle, including problems, may not have been reported to CARFAX. Use this report as one important tool, along with a vehicle inspection and test drive, to make a better decision about your next used car.



## Accident / Damage History

Not all accidents / issues are reported to CARFAX

### Event 1

05/10/2023

#### Damage reported

- It hit debris / object on road

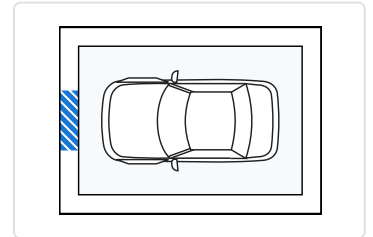

### Event 2

05/15/2023

#### Damage reported: minor damage

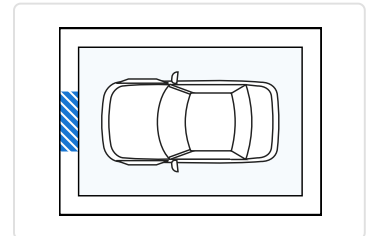
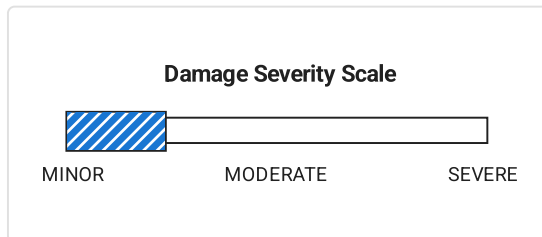

### Event 3

07/03/2025

**Damage reported: moderate damage**

- Damage to undercarriage

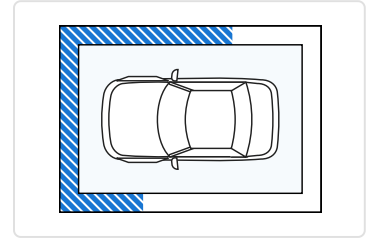
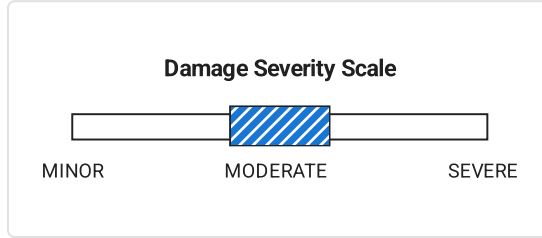

Event 4

10/03/2025

**TOTAL LOSS VEHICLE**

**CARFAX Recent Service Highlights**

Key services performed in the last 12 months

Service & Comments	Service	Comments	Date	View Details Links
Tires	• ✓ Tire(s) replaced	Tires • ✓ Tire(s) replaced	05/01/2025	05/01/25View > View Details >





This car has been recently serviced. That's a good thing!

**CARFAX Additional History**



Not all accidents / issues are reported to CARFAX

	Owner 1	Owner 2
<b>Total Loss</b> Total Loss Reported: 10/03/2025.	✓ No Issues Reported	Total Loss Reported
<b>Structural Damage</b> CARFAX recommends that you have this vehicle inspected by a collision repair specialist.	✓ No Issues Reported	✓ No Issues Reported
<b>Airbag Deployment</b> No airbag deployment reported to CARFAX.	✓ No Issues Reported	✓ No Issues Reported
<b>Odometer Check</b> No indication of an odometer rollback.	✓ No Issues Indicated	✓ No Issues Indicated
<b>Accident / Damage</b> DMV title problems reported. Damage reported: 05/10/2023, 05/15/2023, and 07/03/2025.	Damage Reported	Severe Damage

<b>Manufacturer Recall</b> No open recalls reported to CARFAX. A current list of recalls is available at Ford Motor Company.	<input checked="" type="checkbox"/> No Recalls Reported	<input checked="" type="checkbox"/> No Recalls Reported
<b>Basic Warranty</b> Original manufacturer warranty likely voided by manufacturer.	<input checked="" type="checkbox"/> Warranty Active	<b>Warranty Voided</b>

 <b>Title History</b>	<b>Owner 1</b>	<b>Owner 2</b>
<b>Damage Brands</b> Salvage   Junk   Rebuilt   Fire   Flood   Hail   Lemon	No Problem	<b>Alert!</b> Problem Found
<b>Odometer Brands</b> Not Actual Mileage   Exceeds Mechanical Limits	No Problem	No Problem
 <b>ALERT!</b> - Severe problems were reported by a state Department of Motor Vehicles (DMV). This vehicle does not qualify for the CARFAX Buyback Guarantee.		

 <b>Ownership History</b> The number of owners is estimated	<b>Owner 1</b>	<b>Owner 2</b>
Year purchased	2020	2023
Type of owner	Commercial	Personal
Estimated length of ownership	3 yrs. 3 mo.	2 yrs. 1 mo.
Owned in the following states/provinces	Nevada, Illinois	California
Estimated miles driven per year	16,160/yr	22,039/yr
Last reported odometer reading	52,997	100,529

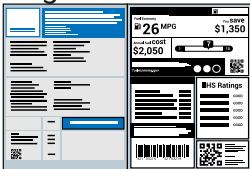
 <b>Detailed History</b>			
 <b>Owner 1</b> Purchased: 2020		Commercial Vehicle 16,160 mi/yr	
Date	Mileage	Source	Comments
02/13/2020		Ford Motor Company	<b>Vehicle manufactured and shipped to original dealer</b>  Original Window Sticker 
03/06/2020		Nevada	<b>Registration issued or renewed</b>

Motor Vehicle Dept.

03/06/2020 Illinois  
Motor Vehicle Dept.  
Des Plaines, IL **Titled or registered as commercial vehicle**

03/06/2020 10 Nevada  
Motor Vehicle Dept.  
Title #NV012507648-4 **Title issued or updated**  
- First owner reported

09/01/2020 7,411 Service Facility  
Las Vegas, NV  **Vehicle serviced**  
- Brakes checked  
- Oil and filter changed  
- Tires rotated

02/16/2021 Nevada  
Motor Vehicle Dept.  
Des Plaines, IL **Registration issued or renewed**

04/02/2021 16,704 Service Facility  
Las Vegas, NV  **Vehicle serviced**  
- Oil and filter changed  
- Tires rotated  
- Wipers/washers checked  
- Wiper(s) replaced

06/11/2021 21,785 Ford Country  
Henderson, NV  
702-566-3673  
fordcountrylv.com  
★ 4.6 / 5.0  
1,961 Verified Reviews  
❤️ 5,405 Customer Favorites  **Vehicle serviced**  
- Maintenance inspection completed  
- Battery/charging system checked  
- Brakes checked  
- Oil and filter changed  
- Tire condition and pressure checked  
- Tire valve stem(s)/core(s) replaced  
- Tire(s) replaced  
- Tires rotated

01/11/2022 Nevada  
Motor Vehicle Dept.  
Des Plaines, IL **Registration issued or renewed**

08/05/2022 39,832 Valvoline Instant Oil Change  
Las Vegas, NV  
702-395-3860  
vioc.com  
★ 4.7 / 5.0  
359 Verified Reviews  
❤️ 41 Customer Favorites  **Vehicle serviced**  
- Recommended maintenance performed  
- A/C system checked  
- Cabin air filter replaced/cleaned  
- Front wiper blades/refills replaced  
- Oil and filter changed  
- Tires rotated  
- Wiper(s) replaced

03/01/2023 Nevada  
Motor Vehicle Dept.  
Des Plaines, IL **Registration issued or renewed**

04/07/2023 51,995 Service Facility  
Las Vegas, NV  **Vehicle serviced**  
- A/C system checked  
- Air filter checked  
- Air filter replaced  
- Cabin air filter replaced/cleaned  
- Oil and filter changed  
- Tire condition and pressure checked  
- Tire valve stem(s)/core(s) replaced

- Tire(s) replaced

05/10/2023

Damage Report



**Damage reported**

- It hit debris / object on road

- Damage to front

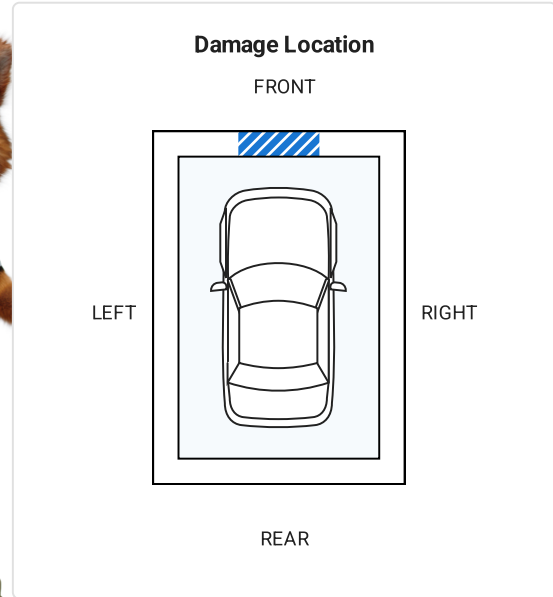

**CARFAX HAS THE MOST ACCIDENT & DAMAGE INFORMATION**

05/15/2023

Damage Report



**Damage reported: minor damage**

- Damage to front

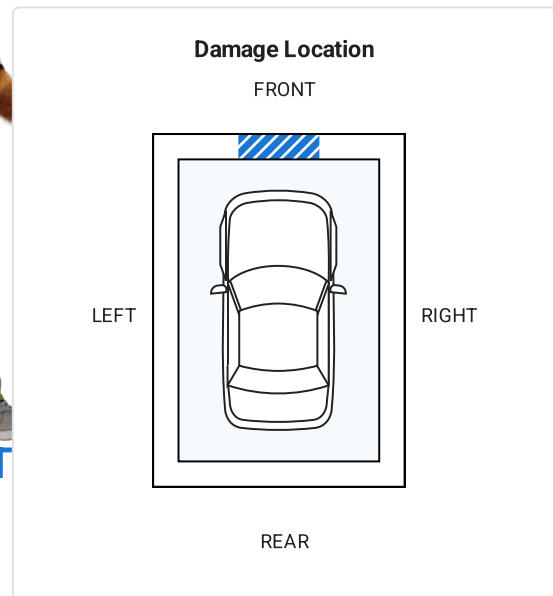
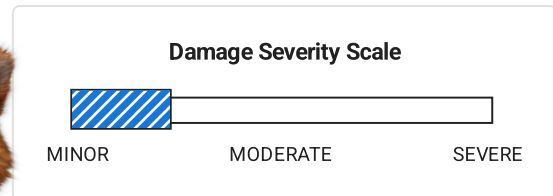

**CARFAX HAS THE MOST ACCIDENT & DAMAGE INFORMATION**

06/16/2023

52,997

Auto Auction

**Vehicle sold**

06/16/2023

Fleet Management Co.  
Clinton, ME





Lease vehicle sold



Owner 2

Purchased: 2023

Personal Vehicle  
22,039 mi/yr

Date	Mileage	Source	Comments
08/12/2023	53,250	California Motor Vehicle Dept. San Diego, CA	<b>Odometer reading reported</b>
09/12/2023		3B Smog Check Station San Diego, CA 858-399-4000 3bautoservices.com/smog-check/ ★ <b>5.0 / 5.0</b> 28 Verified Reviews	 <b>Vehicle serviced</b> - Emissions inspection performed - Emissions or safety inspection performed
09/12/2023	53,990	California Inspection Station	<b>Passed emissions inspection</b>
09/12/2023		California Motor Vehicle Dept. San Diego, CA	<b>Title issued or updated</b> - New owner reported - Loan or lien reported
12/15/2023	57,793	Valvoline Instant Oil Change San Diego, CA 619-282-1145 vioc.com ★ <b>4.4 / 5.0</b> 117 Verified Reviews ❤️ <b>38</b> Customer Favorites	 <b>Vehicle serviced</b> - Fluids checked - Oil and filter changed
02/07/2024		California Motor Vehicle Dept. San Diego, CA	<b>Title issued or updated</b> - Loan or lien reported
11/04/2024		California Motor Vehicle Dept. San Diego, CA	<b>Registration updated when owner moved the vehicle to a new location</b>
05/01/2025	95,898	Pep Boys Escondido, CA 760-741-8426 pepboys.com ★ <b>4.6 / 5.0</b> 107 Verified Reviews ❤️ <b>107</b> Customer Favorites	 <b>Vehicle serviced</b> - Maintenance inspection completed - Tire(s) balanced - Tire(s) mounted - Tire(s) replaced
07/03/2025		Damage Report	 <b>Damage reported: moderate damage</b> - Damage to front - Damage to left front - Damage to undercarriage - Damage to right front

- Damage to right side



**CARFAX HAS THE MOST ACCIDENT & DAMAGE INFORMATION**

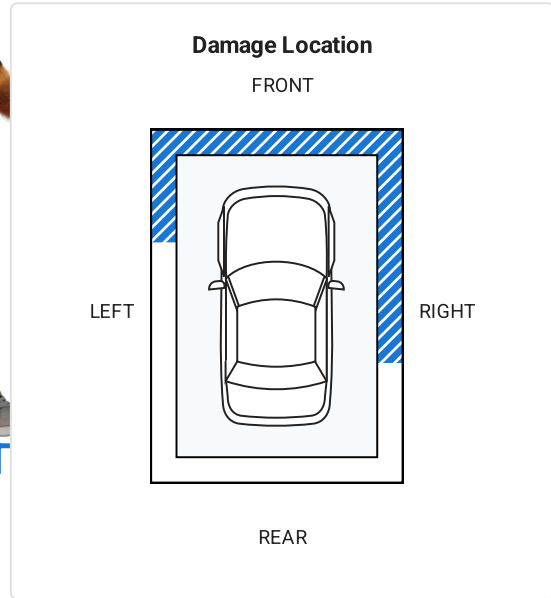
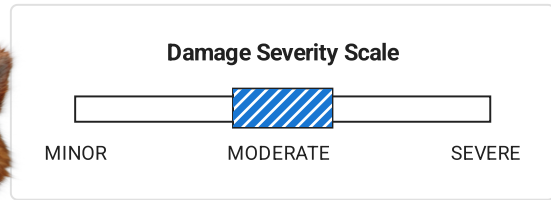

10/03/2025

Damage Report



**TOTAL LOSS VEHICLE**



There are many reasons an insurance company will declare a vehicle a total loss. Have this vehicle inspected by a qualified technician before you buy. [Learn More](#)

10/03/2025

California Motor Vehicle Dept.

**Title or registration issued to insurance company**

10/03/2025

100,529

California Motor Vehicle Dept. Rancho Cucamonga, CA



**SALVAGE TITLE/CERTIFICATE ISSUED**

10/07/2025

Damage Report



**SALVAGE TITLE/CERTIFICATE ISSUED**

Have Questions? Consumers, please visit our Help Center at [www.carfax.com](http://www.carfax.com). Dealers or Subscribers, please visit our Help Center at [www.carfaxonline.com](http://www.carfaxonline.com).



**Glossary**

**Commercial**

Vehicle was registered for business purposes.

**Damage Indicator**

Damage can be a result of many different types of events. Examples include contact with objects (other cars, trees, traffic signs, road debris, etc), vandalism, or weather-related events. Not every damage event is reported to CARFAX. As details about the damage event become available, those additional details are added to the CARFAX Vehicle History Report. CARFAX recommends that you have this vehicle inspected by a qualified mechanic.

- This CARFAX Vehicle History Report is based only on information supplied to CARFAX and available as of 2/5/26 at 8:16:26 AM (CST). Other information about this vehicle, including problems, may not have been reported to CARFAX. Use this report as one important tool, along with a vehicle inspection and test drive, to make a better decision about your next used car.

### Damage Severity

Damage events result in one of the following severity levels:

- Minor: Generally, minor damage is cosmetic (including dents or scratches), may only require reconditioning, and typically does not compromise a vehicle's operation and/or safety.
- Moderate: Moderate damage may affect multiple components of the vehicle and may impair the vehicle's operation and/or safety.
- Severe: Severe damage usually affects multiple components of the vehicle and is likely to compromise the vehicle's operation and/or safety.

CARFAX recommends getting a pre-purchase inspection at a certified collision repair facility.

### First Owner

When the first owner(s) obtains a title from a Department of Motor Vehicles as proof of ownership.

### Ford or Lincoln Mercury Recall

The Ford Motor Company provides CARFAX with Field Service Action and recall information regarding safety, compliance and emissions programs announced since 2000 for a specific vehicle. For complete information regarding programs or concerns about this vehicle, please contact a local Ford or Lincoln Mercury Dealer.

### New Owner Reported

When a vehicle is sold to a new owner, the Title must be transferred to the new owner(s) at a Department of Motor Vehicles.

### Ownership History

CARFAX defines an owner as an individual or business that possesses and uses a vehicle. Not all title transactions represent changes in ownership. To provide estimated number of owners, CARFAX proprietary technology analyzes all the events in a vehicle history. Estimated ownership is available for vehicles manufactured after 1991 and titled solely in the US including Puerto Rico. Dealers sometimes opt to take ownership of a vehicle and are required to in the following states: Maine, Massachusetts, New Jersey, Ohio, Oklahoma, Pennsylvania and South Dakota. Please consider this as you review a vehicle's estimated ownership history.

### Salvage Title

A Salvage Title is issued on a vehicle damaged to the extent that the cost of repairing the vehicle exceeds approximately 75% of its pre-damage value. This damage threshold may vary by state. Some states treat Junk titles the same as Salvage but the majority use this title to indicate that a vehicle is not road worthy and cannot be titled again in that state. The following eleven states also use Salvage titles to identify stolen vehicles - AZ, FL, GA, IL, MD, MN, NJ, NM, NY, OK and OR.

### Title Issued

A state issues a title to provide a vehicle owner with proof of ownership. Each title has a unique number. Each title or registration record on a CARFAX report does not necessarily indicate a change in ownership. In Canada, a registration and bill of sale are used as proof of ownership.

### Total Loss Vehicle

An insurance or fleet company declares a vehicle a total loss when a claim exceeds approximately 75% of its pre-damage value or if the vehicle is stolen and not recovered. This damage threshold varies by company. These companies typically take possession and obtain the title. Not all total loss vehicles result in a DMV-reported branded title. This may occur when an insurance company's definition of a total loss is different than the state DMV's definition for a branded title or when the owner of the vehicle is a self-insured company, like a fleet or rental company.

Follow Us:  [facebook.com/CARFAX](https://facebook.com/CARFAX)  [@CARFAXinc](https://twitter.com/CARFAXinc)  [About CARFAX](#)

CARFAX DEPENDS ON ITS SOURCES FOR THE ACCURACY AND RELIABILITY OF ITS INFORMATION. THEREFORE, NO RESPONSIBILITY IS ASSUMED BY CARFAX OR ITS AGENTS FOR ERRORS OR OMISSIONS IN THIS REPORT. CARFAX FURTHER EXPRESSLY DISCLAIMS ALL WARRANTIES, EXPRESS OR IMPLIED, INCLUDING ANY IMPLIED WARRANTIES OF MERCHANTABILITY OR FITNESS FOR A PARTICULAR PURPOSE.

© 2026 CARFAX, Inc., part of S&P Global. All rights reserved.  
2/5/26 8:16:26 AM (CST)

**I have reviewed and received a copy of the CARFAX Vehicle History Report for this 2020 FORD FUSION HYBRID vehicle (VIN: 3FA6P0LU1LR195637), which is based on information supplied to CARFAX and available as of 2/5/26 at 9:16 AM (EST).**

---

**Customer Signature**

**Date**

---

**Dealer Signature**

**Date**