



Report

US \$44.99

2021 Subaru Outback Limited

82,876 mi
VIN: 4S4BTAMC1M3141881
4 Door Wagon/Sport Utility
2.5L H4 F DOHC 16V
Gasoline
All wheel drive

CARFAX HAS THE MOST
ACCIDENT & DAMAGE
INFORMATION



branded title



Salvage



9 Service history records



At least 1 open recall



CARFAX 1-Owner vehicle



Personal vehicle



Last owned in Missouri

This CARFAX Vehicle History Report is based only on information supplied to CARFAX and available as of 4/1/26 at 3:35:38 AM (CDT). Other information about this vehicle, including problems, may not have been reported to CARFAX. Use this report as one important tool, along with a vehicle inspection and test drive, to make a better decision about your next used car.



Accident / Damage History

Not all accidents / issues are reported to CARFAX

Event 1

01/10/2025

Damage reported: minor damage

Damage Severity Scale

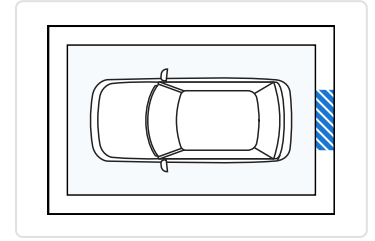
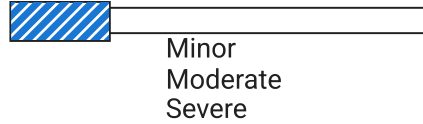

Event 2

02/02/2026

Accident reported: minor damage

- Vehicle towed

Damage Severity Scale

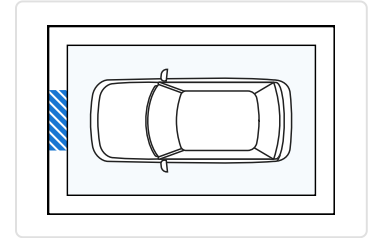
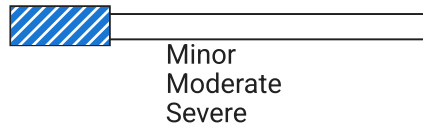

Event 3

03/20/2026

TOTAL LOSS VEHICLE



Additional History

Not all accidents / issues are reported to CARFAX

Owner 1

Total Loss

Total Loss Reported: 03/20/2026.

Total Loss Reported

Structural Damage

CARFAX recommends that you have this vehicle inspected by a collision repair specialist.

✓ No Issues Reported

Airbag Deployment

No airbag deployment reported to CARFAX.

✓ No Issues Reported

Odometer Check

No indication of an odometer rollback.

✓ No Issues Indicated

Accident / Damage

DMV title problems reported. Damage reported: 01/10/2025. Accident reported: 02/02/2026.

Severe Damage

Manufacturer Recall

At least 1 manufacturer recall requires repair. Most recalls can be repaired free of charge.

Recall Reported

Basic Warranty

Original manufacturer warranty likely voided by manufacturer.

Warranty Voided



Title History

Owner 1

Damage Brands

Salvage | Junk | Rebuilt | Fire | Flood | Hail | Lemon

Alert!
Problem Found

Odometer Brands

Not Actual Mileage | Exceeds Mechanical Limits

No Problem



ALERT! - Severe problems were reported by a state Department of Motor Vehicles (DMV). This vehicle does not qualify for the CARFAX Buyback Guarantee.



Ownership History

The number of owners is estimated

Owner 1

Year purchased

2020

Type of owner

Personal

Estimated length of ownership

5 yrs. 2 mo.

Owned in the following states/provinces

Missouri

Estimated miles driven per year

15,822/yr

Last reported odometer reading

82,876



Detailed History



Owner 1

Purchased: 2020

Personal Vehicle

15,822 mi/yr

Date

Mileage

Source

Comments

11/28/2020

5

Subaru of Columbia
Columbia, MO
573-777-3488
subaruofcolumbia.com

Vehicle offered for sale

★ 4.7 / 5.0

561 Verified Reviews

♥ 7,623 Customer Favorites

12/01/2020

Subaru of Columbia
Columbia, MO
573-777-3488
subaruofcolumbia.com



Vehicle serviced

- Pre-delivery inspection completed

★ 4.7 / 5.0

561 Verified Reviews

♥ 7,623 Customer Favorites

12/11/2020

8

Subaru of Columbia
Columbia, MO



Vehicle serviced

- Pre-delivery inspection completed

573-777-3488
subaruofcolumbia.com
★ 4.7 / 5.0
561 Verified Reviews
❤️ 7,623 Customer Favorites

12/21/2020

Subaru of Columbia
Columbia, MO
573-777-3488
subaruofcolumbia.com
★ 4.7 / 5.0
561 Verified Reviews
❤️ 7,623 Customer Favorites

Vehicle sold

12/26/2020 424

Missouri
Motor Vehicle Dept.

Vehicle purchase reported
- Titled or registered as personal vehicle

12/29/2020

Dealer Inventory

Vehicle offered for sale

12/31/2020

Subaru of Olathe
OLATHE, KS
888-905-2246
https://subaruofolathe.com
★ 4.8 / 5.0
401 Verified Reviews
❤️ 51 Customer Favorites



Vehicle serviced
- Pre-delivery inspection completed

02/09/2021

Missouri
Motor Vehicle Dept.
Kansas City, MO
Title #UAA69337

Title issued or updated
- First owner reported
- Loan or lien reported

07/22/2021

Missouri
Motor Vehicle Dept.
Kansas City, MO
Title #UAA69337

Registration issued or renewed
- Loan or lien reported

01/05/2022

Missouri
Motor Vehicle Dept.
Kansas City, MO
Title #UAA69337

Registration issued or renewed
- Loan or lien reported

08/24/2022 21,434

Meineke Car Care Center
Overland Park, KS
913-338-4966
meineke.com
★ 4.3 / 5.0
135 Verified Reviews
❤️ 2,340 Customer Favorites



Vehicle serviced
- Fluids checked
- Oil and filter changed

08/10/2023 41,376

Meineke Car Care Center
Overland Park, KS
913-338-4966
meineke.com
★ 4.3 / 5.0
135 Verified Reviews



Vehicle serviced
- Fluids checked
- Oil and filter changed

♥ 2,340 Customer Favorites

11/11/2023 45,997

Subaru of Olathe
OLATHE, KS
888-905-2246
<https://subaruofolathe.com>

★ 4.8 / 5.0

401 Verified Reviews

♥ 51 Customer Favorites



Vehicle serviced

- Maintenance inspection completed
- Battery replaced

11/16/2023

Missouri
Motor Vehicle Dept.
Kansas City, MO
Title #UAA69337

Registration issued or renewed

- Loan or lien reported

12/28/2023

KC Automotive
Kansas City, MO
816-997-9980
kccompleteauto.com

★ 4.8 / 5.0

84 Verified Reviews

♥ 40 Customer Favorites



Vehicle serviced

01/03/2024 48,073

Subaru of Olathe
OLATHE, KS
888-905-2246
<https://subaruofolathe.com>

★ 4.8 / 5.0

401 Verified Reviews

♥ 51 Customer Favorites



Vehicle serviced

- Inspection performed
- Alignment checked
- Tire checked
- Maintenance inspection completed
- Fuel line/hose replaced
- Intake manifold gasket(s) replaced

[View the complete inspection report](#)

03/22/2024

Subaru of America

Manufacturer Safety recall issued

- NHTSA #24V227000
- Recall #WRA24 ODS SENSOR FAILURE, POWER SEAT
- Status: Limited Parts Available

[Click Here](#) or email us at customers@subaru.com to locate an authorized Subaru dealership near you to obtain more information about this recall.

[+ Learn more about this recall](#)

01/10/2025

Damage Report

Damage reported: minor damage

- Damage to rear

Damage Severity Scale



Minor
Moderate
Severe

Damage Location

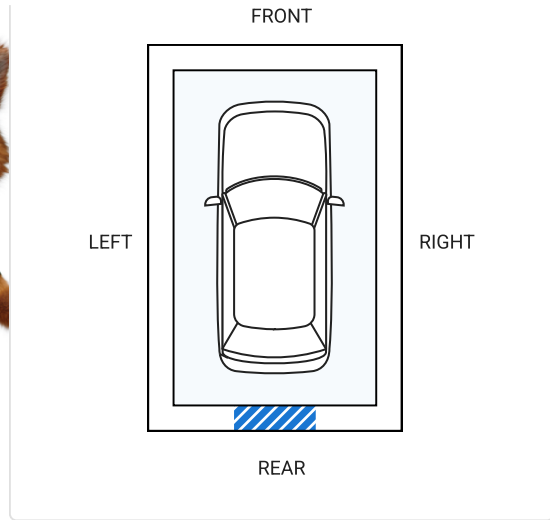

CARFAX HAS THE MOST ACCIDENT & DAMAGE INFORMATION

02/17/2025

68,096

KC Automotive
Kansas City, MO
816-997-9980
kccompleteauto.com



Vehicle serviced
- Oil and filter changed

★ 4.8 / 5.0

84 Verified Reviews

♥ 40 Customer Favorites

12/30/2025

Missouri
Motor Vehicle Dept.
Kansas City, MO
Title #UAA69337

Registration issued or renewed
- Loan or lien reported

02/02/2026

Damage Report

Accident reported: minor damage
- Damage to front
- Vehicle towed

Damage Severity Scale



Minor
Moderate
Severe

Damage Location



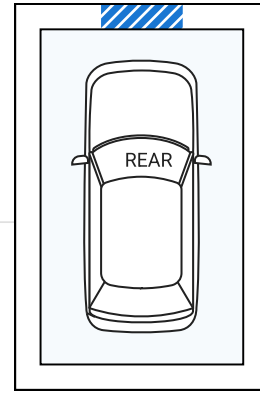

FRONT

LEFT

RIGHT



CARFAX HAS THE MOST ACCIDENT & DAMAGE INFORMATION

| | | | |
|------------|--------|---|---|
| 03/12/2026 | 82,876 | Missouri Motor Vehicle Dept. | Vehicle purchase reported |
| 03/20/2026 | | Damage Report |  TOTAL LOSS VEHICLE |
| | |  | <div style="border: 1px solid blue; padding: 5px;"> <p>There are many reasons an insurance company will declare a vehicle a total loss. Have this vehicle inspected by a qualified technician before you buy. Learn More</p> </div> |
| 03/20/2026 | | Missouri Motor Vehicle Dept. | Title or registration issued to insurance company |
| 03/20/2026 | | Missouri Motor Vehicle Dept. Fairfield, OH Title #UAH60307 |  SALVAGE TITLE/CERTIFICATE ISSUED |
| 03/26/2026 | | Auto Auction | Vehicle sold |
| 03/26/2026 | | Damage Report |  SALVAGE TITLE/CERTIFICATE ISSUED |

Have Questions? Consumers, please visit our Help Center at www.carfax.com. Dealers or Subscribers, please visit our Help Center at www.carfaxonline.com.



Glossary

Accident Indicator

CARFAX receives information about accidents in all 50 states, the District of Columbia and Canada.

Not every accident is reported to CARFAX. As details about the accident become available, those additional details are added to the CARFAX Vehicle History Report. CARFAX recommends that you have this vehicle inspected by a qualified mechanic.

- According to the National Safety Council, Injury Facts, 2021 edition, 5% of the 276 million registered vehicles in the U.S. were involved in an accident in 2019. Over 77% of these were considered minor or moderate.
- This CARFAX Vehicle History Report is based only on information supplied to CARFAX and available as of 4/1/26 at 3:35:38 AM (CDT). Other information about this vehicle, including problems, may not have been reported to CARFAX. Use this report as one important tool, along with a vehicle inspection and test drive, to make a better decision about your next used car.

Damage Indicator

Damage can be a result of many different types of events. Examples include contact with objects (other cars, trees, traffic signs, road debris, etc), vandalism, or weather-related events. Not every damage event is reported to CARFAX. As details about the damage event become available, those additional details are added to the CARFAX Vehicle History Report. CARFAX recommends that you have this vehicle inspected by a qualified mechanic.

- This CARFAX Vehicle History Report is based only on information supplied to CARFAX and available as of 4/1/26 at 3:35:38 AM (CDT). Other information about this vehicle, including problems, may not have been reported to CARFAX. Use this report as one important tool, along with a vehicle inspection and test drive, to make a better decision about your next used car.

Damage Severity

Damage events result in one of the following severity levels:

- Minor: Generally, minor damage is cosmetic (including dents or scratches), may only require reconditioning, and typically does not compromise a vehicle's operation and/or safety.
- Moderate: Moderate damage may affect multiple components of the vehicle and may impair the vehicle's operation and/or safety.
- Severe: Severe damage usually affects multiple components of the vehicle and is likely to compromise the vehicle's operation and/or safety.

CARFAX recommends getting a pre-purchase inspection at a certified collision repair facility.

First Owner

When the first owner(s) obtains a title from a Department of Motor Vehicles as proof of ownership.

Manufacturer Recall

Automobile manufacturers issue recall notices to inform vehicle owners of a safety defect or failure to meet minimum federal safety or emissions standards. Manufacturer recalls are repaired at no cost to the customer.

Ownership History

CARFAX defines an owner as an individual or business that possesses and uses a vehicle. Not all title transactions represent changes in ownership. To provide estimated number of owners, CARFAX proprietary technology analyzes all the events in a vehicle history. Estimated ownership is available for vehicles manufactured after 1991 and titled solely in the US including Puerto Rico. Dealers sometimes opt to take ownership of a vehicle and are required to in the following states: Maine, Massachusetts, New Jersey, Ohio, Oklahoma, Pennsylvania and South Dakota. Please consider this as you review a vehicle's estimated ownership history.

Salvage Title

A Salvage Title is issued on a vehicle damaged to the extent that the cost of repairing the vehicle exceeds approximately 75% of its pre-damage value. This damage threshold may vary by state. Some states treat Junk titles the same as Salvage but the majority use this title to indicate that a vehicle is not road worthy and cannot be titled again in that state. The following eleven states also use Salvage titles to identify stolen vehicles - AZ, FL, GA, IL, MD, MN, NJ, NM, NY, OK and OR.

Title Issued

A state issues a title to provide a vehicle owner with proof of ownership. Each title has a unique number. Each title or registration record on a CARFAX report does not necessarily indicate a change in ownership. In Canada, a registration and bill of sale are used as proof of ownership.

Total Loss Vehicle

An insurance or fleet company declares a vehicle a total loss when a claim exceeds approximately 75% of its pre-damage value or if the vehicle is stolen and not recovered. This damage threshold varies by company. These companies typically take possession and obtain the title. Not all total loss vehicles result in a DMV-reported branded title. This may occur when an insurance company's definition of a total loss is different than the state DMV's definition for a branded title or when the owner of the vehicle is a self-insured company, like a fleet or rental company.

Full Glossary

CARFAX DEPENDS ON ITS SOURCES FOR THE ACCURACY AND RELIABILITY OF ITS INFORMATION. THEREFORE, NO RESPONSIBILITY IS ASSUMED BY CARFAX OR ITS AGENTS FOR ERRORS OR OMISSIONS IN THIS REPORT. CARFAX FURTHER EXPRESSLY DISCLAIMS ALL WARRANTIES, EXPRESS OR IMPLIED, INCLUDING ANY IMPLIED WARRANTIES OF MERCHANTABILITY OR FITNESS FOR A PARTICULAR PURPOSE.

© 2026 CARFAX, Inc., part of S&P Global. All rights reserved.
4/1/26 3:35:38 AM (CDT)

I have reviewed and received a copy of the CARFAX Vehicle History Report for this 2021 SUBARU OUTBACK vehicle (VIN: 4S4BTAMC1M3141881), which is based on information supplied to CARFAX and available as of 4/1/26 at 4:35 AM (EDT).

Customer Signature

Date

Dealer Signature

Date