



# Report

US \$44.99

## 2021 Volkswagen Jetta S

73,906 mi

VIN: 3VWC57BU1MM027179

Sedan 4 DR

- 1.4L I4 F DOHC 16V
- Gasoline
- Front wheel drive



BRANDED TITLE

Salvage

CARFAX VALUE \$11,290

GREAT RELIABILITY

Fair Good Great

20 Service History Records

2 Previous Owners

Types of Owners: Personal Lease, Personal

Last Owned in Louisiana

32 Detailed Records Available

This CARFAX Vehicle History Report is based only on information supplied to CARFAX and available as of 4/30/26 at 7:33:27 AM (CDT). Other information about this vehicle, including problems, may not have been reported to CARFAX. Use this report as one important tool, along with a vehicle inspection and test drive, to make a better decision about your next used car.



## Accident / Damage History

Not all accidents / issues are reported to CARFAX

### Event 1

02/23/2022

Damage reported: minor damage

Damage Severity Scale



Minor Moderate Severe

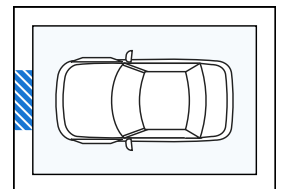

### Event 2

02/24/2026

Damage reported: minor to moderate damage

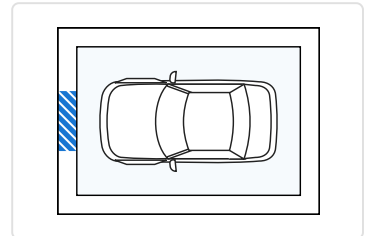
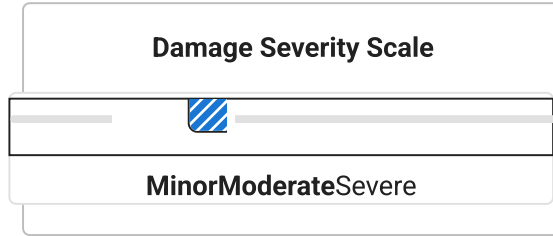

### Recent Service Highlights

Key services performed in the last 12 months

Service	Comments	Date
Oil	Oil and filter changed	12/29/2025

This car has been recently serviced. That's a good thing!



### History-Based Value Report

# \$11,290

CARFAX Retail Value

#### History events affecting this vehicle's value

- Service History
- Personal Vehicle
- Salvage Brand



### Reliability Forecast

Based on 2021 Volkswagen Jetta S with similar mileage

#### 3-Year Reliability Forecast

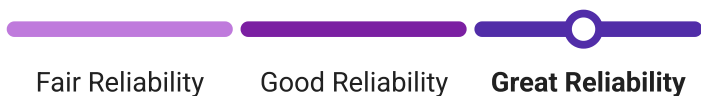

#### What makes this vehicle have **great reliability**?

- Top 25%** compared to similar vehicles
- Low Repair Cost**  
\$220 avg per year
- Oil Changes** performed regularly

 **Low Likelihood of Repair**

Good news! This vehicle is expected to have low risk of repair and low repair costs.

 <b>Additional History</b> Not all accidents / issues are reported to CARFAX	Owner 1	Owner 2
<b>Total Loss</b> No total loss reported to CARFAX.	<input checked="" type="checkbox"/> No Issues Reported	<input checked="" type="checkbox"/> No Issues Reported
<b>Structural Damage</b> CARFAX recommends that you have this vehicle inspected by a collision repair specialist.	<input checked="" type="checkbox"/> No Issues Reported	<input checked="" type="checkbox"/> No Issues Reported
<b>Airbag Deployment</b> No airbag deployment reported to CARFAX.	<input checked="" type="checkbox"/> No Issues Reported	<input checked="" type="checkbox"/> No Issues Reported
<b>Odometer Check</b> No indication of an odometer rollback.	<input checked="" type="checkbox"/> No Issues Indicated	<input checked="" type="checkbox"/> No Issues Indicated
<b>Accident / Damage</b> DMV title problems reported. Damage reported: 02/23/2022 and 02/24/2026.	Damage Reported	Severe Damage
<b>Manufacturer Recall</b> No open recalls reported to CARFAX.	<input checked="" type="checkbox"/> No Recalls Reported	<input checked="" type="checkbox"/> No Recalls Reported
<b>Basic Warranty</b> Original manufacturer warranty likely voided by manufacturer.	<input checked="" type="checkbox"/> Warranty Active	<b>Warranty Voided</b>

 <b>Title History</b>	Owner 1	Owner 2
<b>Damage Brands</b> Salvage   Junk   Rebuilt   Fire   Flood   Hail   Lemon	No Problem	<b>Alert!</b> Problem Found
<b>Odometer Brands</b> Not Actual Mileage   Exceeds Mechanical Limits	No Problem	No Problem



**ALERT!** - Severe problems were reported by a state Department of Motor Vehicles (DMV). This vehicle does not qualify for the CARFAX Buyback Guarantee.

 <b>Ownership History</b> The number of owners is estimated	Owner 1	Owner 2
Year purchased	2021	2024
Type of owner	Personal Lease	Personal
	2 yrs. 11 mo.	1 yr. 10 mo.

Estimated length of ownership		
Owned in the following states/provinces	Florida	Louisiana
Estimated miles driven per year	3,724/yr	42,243/yr
Last reported odometer reading	11,032	73,906



## Detailed History



**Owner 1**

Purchased: 2021

Personal Lease  
Vehicle  
3,724 mi/yr

Date	Mileage	Source	Comments
Not Reported		NICB	<b>Vehicle manufactured and shipped to original dealer</b>
01/11/2021	15	Schumacher Volkswagen of West Palm Beach West Palm Beach, FL 844-807-6811 <a href="https://vwofwestpalmbeach.com/">https://vwofwestpalmbeach.com/</a> ★ 4.4 / 5.0 145 Verified Reviews ❤️ 8 Customer Favorites	 <b>Vehicle serviced</b> - Pre-delivery inspection completed
03/30/2021	88	Florida Motor Vehicle Dept. Boynton Beach, FL Title #0142033485	<b>Vehicle purchase reported</b> - Title issued or updated - Registration issued or renewed - First owner reported - Titled or registered as personal lease vehicle - Loan or lien reported - Vehicle color noted as Blue
08/13/2021		Florida Motor Vehicle Dept. Boynton Beach, FL Title #0142033485	<b>Registration issued or renewed</b> - Loan or lien reported - Vehicle color noted as Blue
02/23/2022		Damage Report	<b>Damage reported: minor damage</b> - Damage to front

**Damage Severity Scale**

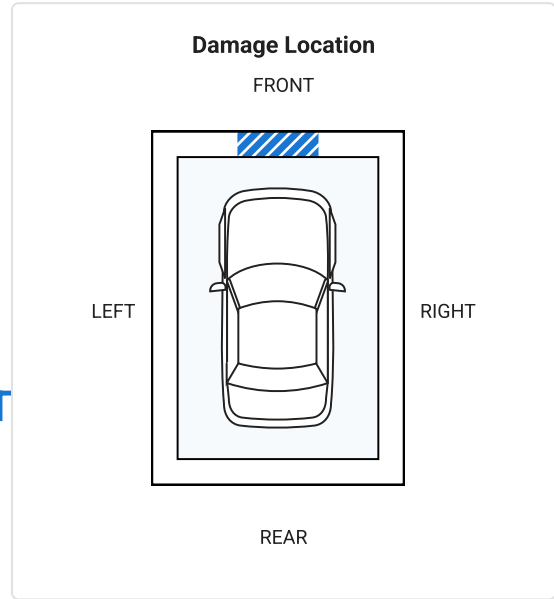
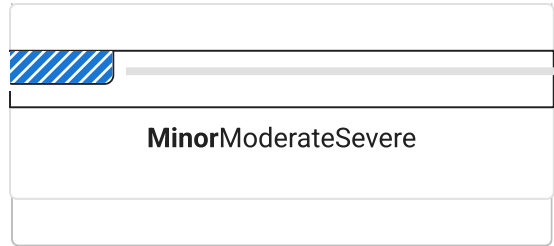

**CARFAX HAS THE MOST ACCIDENT & DAMAGE INFORMATION**

08/17/2022		Florida Motor Vehicle Dept. Boynton Beach, FL Title #0142033485		<b>Registration issued or renewed</b> - Loan or lien reported - Vehicle color noted as Blue
08/18/2022	5,130	Schumacher Volkswagen of West Palm Beach West Palm Beach, FL 844-807-6811 <a href="https://vwofwestpalmbeach.com/">https://vwofwestpalmbeach.com/</a> ★ 4.4 / 5.0 145 Verified Reviews ❤️ 8 Customer Favorites		<b>Vehicle serviced</b> - Maintenance inspection completed - Recommended maintenance performed - Brakes checked - Cabin air filter replaced/cleaned - Oil and filter changed - Tires rotated
07/17/2023	8,386	Schumacher Volkswagen of West Palm Beach West Palm Beach, FL 844-807-6811 <a href="https://vwofwestpalmbeach.com/">https://vwofwestpalmbeach.com/</a> ★ 4.4 / 5.0 145 Verified Reviews ❤️ 8 Customer Favorites		<b>Vehicle serviced</b> - Maintenance inspection completed - Recommended maintenance performed - 30,000 mile service performed - Battery/charging system checked - Battery replaced - Brakes checked - Brake fluid flushed/changed - Oil and filter changed
08/25/2023		Florida Motor Vehicle Dept. Boynton Beach, FL Title #0142033485		<b>Registration issued or renewed</b> - Loan or lien reported - Vehicle color noted as Blue
03/04/2024	10,938	Schumacher Volkswagen of West Palm Beach		<b>Vehicle serviced</b> - Maintenance inspection completed

West Palm Beach, FL  
844-807-6811  
<https://vwofwestpalmbeach.com/>

★ 4.4 / 5.0

145 Verified Reviews

♥ 8 Customer Favorites

03/15/2024 11,032

Schumacher Volkswagen of West Palm Beach  
West Palm Beach, FL  
844-807-6811  
<https://vwofwestpalmbeach.com/>



**Vehicle serviced**  
- Vehicle washed/detailed

★ 4.4 / 5.0

145 Verified Reviews

♥ 8 Customer Favorites

03/18/2024

Online Listing

**Vehicle offered for sale**



**Owner 2**

Purchased: 2024

Personal Vehicle

42,243 mi/yr

Date	Mileage	Source	Comments
------	---------	--------	----------

06/13/2024

Louisiana  
Motor Vehicle Dept.

**Vehicle purchase reported**

07/05/2024 11,178

Louisiana  
Motor Vehicle Dept.  
New Orleans, LA

**Title issued or updated**  
- New owner reported  
- Loan or lien reported  
- Vehicle color noted as Blue

07/15/2024 15,559

Valvoline Instant Oil Change  
San Antonio, TX  
210-822-9522  
[vioc.com](http://vioc.com)



**Vehicle serviced**  
- Oil and filter changed

★ 4.8 / 5.0

570 Verified Reviews

♥ 231 Customer Favorites

08/17/2024 18,247

Valvoline Instant Oil Change  
Shavano Park, TX  
210-479-2299  
[vioc.com](http://vioc.com)



**Vehicle serviced**  
- Fuel injection system checked  
- Fuel system cleaned/serviced  
- Oil and filter changed

★ 4.8 / 5.0

452 Verified Reviews

♥ 176 Customer Favorites

09/12/2024 21,177

Brake Check Austin  
Highway  
San Antonio, TX  
210-824-6868  
[brakecheck.com/](http://brakecheck.com/)



**Vehicle serviced**  
- Brakes checked  
- Brake pads replaced  
- Oil and filter changed

★ 4.7 / 5.0

39 Verified Reviews

 17 Customer Favorites

10/16/2024 24,117

Brake Check Austin Highway  
San Antonio, TX  
210-824-6868  
brakecheck.com/



**Vehicle serviced**  
- Brakes checked  
- Oil and filter changed

 4.7 / 5.0

39 Verified Reviews

 17 Customer Favorites

11/20/2024 28,578

Brake Check Austin Highway  
San Antonio, TX  
210-824-6868  
brakecheck.com/



**Vehicle serviced**  
- Brakes checked  
- Fluids checked  
- Oil and filter changed

 4.7 / 5.0

39 Verified Reviews

 17 Customer Favorites

12/04/2024 31,677

Brake Check Austin Highway  
San Antonio, TX  
210-824-6868  
brakecheck.com/



**Vehicle serviced**  
- Brakes checked  
- Oil and filter changed

 4.7 / 5.0

39 Verified Reviews

 17 Customer Favorites

01/22/2025 37,176

Brake Check Austin Highway  
San Antonio, TX  
210-824-6868  
brakecheck.com/



**Vehicle serviced**  
- Brakes checked  
- Oil and filter changed

 4.7 / 5.0

39 Verified Reviews

 17 Customer Favorites

02/22/2025 40,200

Brake Check Austin Highway  
San Antonio, TX  
210-824-6868  
brakecheck.com/



**Vehicle serviced**  
- Brakes checked

 4.7 / 5.0

39 Verified Reviews

 17 Customer Favorites

02/28/2025

Brake Check Blanco Road  
San Antonio, TX  
210-341-7121  
brakecheck.com/









**Vehicle serviced**  
- Brakes checked  
- Oil and filter changed

 4.4 / 5.0

43 Verified Reviews

 14 Customer Favorites

03/29/2025	43,542	<p>Brake Check Perrin Beitel San Antonio, TX 210-657-9696 brakecheck.com/</p> <p>★ 4.4 / 5.0 45 Verified Reviews ♥ 4 Customer Favorites</p>	 <p><b>Vehicle serviced</b> - Brakes checked - Oil and filter changed</p>
05/16/2025	47,845	<p>Brake Check Austin Highway San Antonio, TX 210-824-6868 brakecheck.com/</p> <p>★ 4.7 / 5.0 39 Verified Reviews ♥ 17 Customer Favorites</p>	 <p><b>Vehicle serviced</b> - Brakes checked - Fluids checked - Oil and filter changed</p>
06/13/2025	51,602	<p>Brake Check Perrin Beitel San Antonio, TX 210-657-9696 brakecheck.com/</p> <p>★ 4.4 / 5.0 45 Verified Reviews ♥ 4 Customer Favorites</p>	 <p><b>Vehicle serviced</b> - Brakes checked - Cabin air filter replaced/cleaned - Oil and filter changed</p>
08/01/2025	57,543	<p>Brake Check Austin Highway San Antonio, TX 210-824-6868 brakecheck.com/</p> <p>★ 4.7 / 5.0 39 Verified Reviews ♥ 17 Customer Favorites</p>	 <p><b>Vehicle serviced</b> - Brakes checked - Fluids checked - Oil and filter changed</p>
12/04/2025	70,903	<p>Brake Check Perrin Beitel San Antonio, TX 210-657-9696 brakecheck.com/</p> <p>★ 4.4 / 5.0 45 Verified Reviews ♥ 4 Customer Favorites</p>	 <p><b>Vehicle serviced</b> - Brakes checked - Oil and filter changed</p>
12/29/2025	73,906	<p>Brake Check Perrin Beitel San Antonio, TX 210-657-9696 brakecheck.com/</p> <p>★ 4.4 / 5.0 45 Verified Reviews ♥ 4 Customer Favorites</p>	 <p><b>Vehicle serviced</b> - Brakes checked - Oil and filter changed</p>
02/24/2026		<p>Damage Report</p>	 <p><b>Damage reported: minor to moderate damage</b> - Damage to front</p>

## CARFAX HAS THE MOST ACCIDENT & DAMAGE INFORMATION

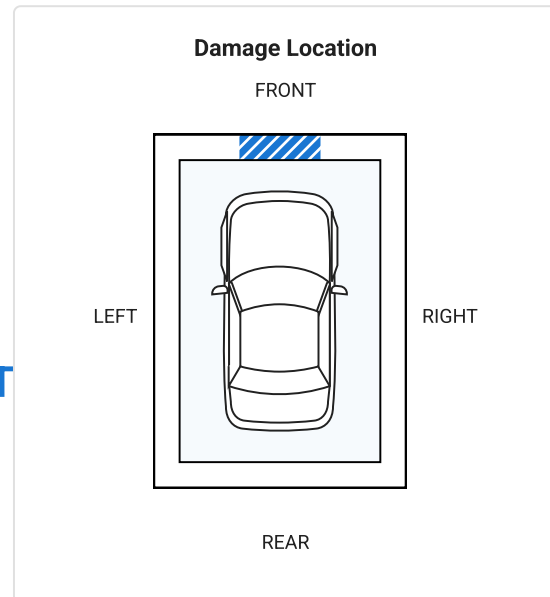
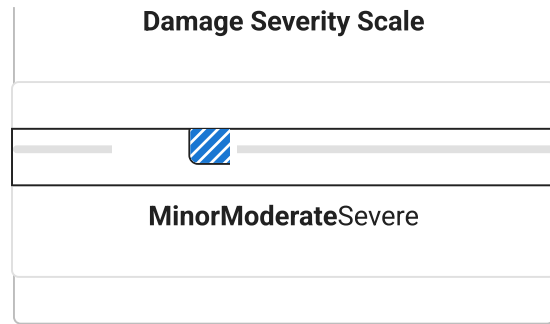

04/03/2026

Louisiana  
Motor Vehicle Dept.  
New Orleans, LA

**Title issued or updated**

- Dealer took title of this vehicle while it was in inventory
- Vehicle color noted as Blue

04/28/2026

Damage Report



**SALVAGE TITLE/CERTIFICATE ISSUED**

Have Questions? Consumers, please visit our Help Center at [www.carfax.com](http://www.carfax.com). Dealers or Subscribers, please visit our Help Center at [www.carfaxonline.com](http://www.carfaxonline.com).



## Glossary

### Damage Indicator

Damage can be a result of many different types of events. Examples include contact with objects (other cars, trees, traffic signs, road debris, etc), vandalism, or weather-related events. Not every damage event is reported to CARFAX. As details about the damage event become available, those additional details are added to the CARFAX Vehicle History Report. CARFAX recommends that you have this vehicle inspected by a qualified mechanic.

- This CARFAX Vehicle History Report is based only on information supplied to CARFAX and available as of 4/30/26 at 7:33:27 AM (CDT). Other information about this vehicle, including problems, may not have been reported to CARFAX. Use this report as one important tool, along with a vehicle inspection and test drive, to make a better decision about your next used car.

### Damage Severity

Damage events result in one of the following severity levels:

- Minor: Generally, minor damage is cosmetic (including dents or scratches), may only require reconditioning, and typically does not compromise a vehicle's operation and/or safety.
- Moderate: Moderate damage may affect multiple components of the vehicle and may impair the vehicle's operation and/or safety.

- Severe: Severe damage usually affects multiple components of the vehicle and is likely to compromise the vehicle's operation and/or safety.

CARFAX recommends getting a pre-purchase inspection at a certified collision repair facility.

**First Owner**

When the first owner(s) obtains a title from a Department of Motor Vehicles as proof of ownership.

**New Owner Reported**

When a vehicle is sold to a new owner, the Title must be transferred to the new owner(s) at a Department of Motor Vehicles.

**Ownership History**

CARFAX defines an owner as an individual or business that possesses and uses a vehicle. Not all title transactions represent changes in ownership. To provide estimated number of owners, CARFAX proprietary technology analyzes all the events in a vehicle history. Estimated ownership is available for vehicles manufactured after 1991 and titled solely in the US including Puerto Rico. Dealers sometimes opt to take ownership of a vehicle and are required to in the following states: Maine, Massachusetts, New Jersey, Ohio, Oklahoma, Pennsylvania and South Dakota. Please consider this as you review a vehicle's estimated ownership history.

**Reliability Forecast**

The CARFAX 3-Year Reliability Forecast predicts the likelihood of repairs for a vehicle over the next three years. This forecast is based on vehicles of the same year, make, and model with similar mileage, damage, service history, and other factors, and assumes an average of 15,000 miles driven per year. Repairs are separate from regular maintenance, such as oil changes. Some of the repairs predicted may be covered under warranty. The 3-Year Reliability Forecast is based on data reported to Carfax and is only a prediction, not a guarantee.

**Salvage Title**

A Salvage Title is issued on a vehicle damaged to the extent that the cost of repairing the vehicle exceeds approximately 75% of its pre-damage value. This damage threshold may vary by state. Some states treat Junk titles the same as Salvage but the majority use this title to indicate that a vehicle is not road worthy and cannot be titled again in that state. The following eleven states also use Salvage titles to identify stolen vehicles - AZ, FL, GA, IL, MD, MN, NJ, NM, NY, OK and OR.

**Title Issued**

A state issues a title to provide a vehicle owner with proof of ownership. Each title has a unique number. Each title or registration record on a CARFAX report does not necessarily indicate a change in ownership. In Canada, a registration and bill of sale are used as proof of ownership.

Follow Us:  [facebook.com/CARFAX](https://facebook.com/CARFAX)  [@CARFAXinc](https://twitter.com/CARFAXinc)  [About CARFAX](#)

CARFAX DEPENDS ON ITS SOURCES FOR THE ACCURACY AND RELIABILITY OF ITS INFORMATION. THEREFORE, NO RESPONSIBILITY IS ASSUMED BY CARFAX OR ITS AGENTS FOR ERRORS OR OMISSIONS IN THIS REPORT. CARFAX FURTHER EXPRESSLY DISCLAIMS ALL WARRANTIES, EXPRESS OR IMPLIED, INCLUDING ANY IMPLIED WARRANTIES OF MERCHANTABILITY OR FITNESS FOR A PARTICULAR PURPOSE.

© 2026 CARFAX, Inc., part of S&P Global. All rights reserved.  
4/30/26 7:33:27 AM (CDT)

**I have reviewed and received a copy of the CARFAX Vehicle History Report for this 2021 VOLKSWAGEN JETTA vehicle (VIN: 3VWC57BU1MM027179), which is based on information supplied to CARFAX and available as of 4/30/26 at 8:33 AM (EDT).**

\_\_\_\_\_  
**Customer Signature**

\_\_\_\_\_  
**Date**

\_\_\_\_\_  
**Dealer Signature**

\_\_\_\_\_  
**Date**