



Report

US \$44.99

2014 Honda Odyssey EX

203,129 mi | VIN: 5FNRL5H48EB121564 |

Van | 3.5L V6 F SOHC 24V | Gasoline | Front wheel drive

CARFAX HAS THE MOST ACCIDENT & DAMAGE INFORMATION



BRANDED TITLE

Salvage

CARFAX VALUE \$3,600

37 Service History Records

1 CARFAX 1-Owner Vehicle

Personal Vehicle

Last Owned in New York

64 Detailed Records Available

This CARFAX Vehicle History Report is based only on information supplied to CARFAX and available as of 5/25/26 at 8:15:11 AM (CDT). Other information about this vehicle, including problems, may not have been reported to CARFAX. Use this report as one important tool, along with a vehicle inspection and test drive, to make a better decision about your next used car.



Accident / Damage History

Not all accidents / issues are reported to CARFAX

Event 1

11/27/2015

Accident reported: minor damage with another motor vehicle

Damage Severity Scale

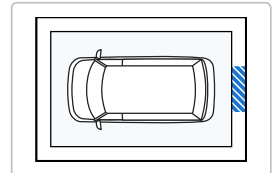
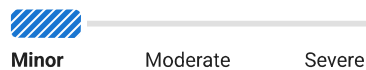

Event 2

05/02/2023

Accident reported: minor damage with another motor vehicle

Damage Severity Scale

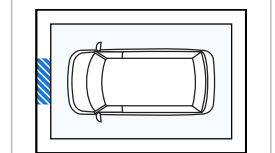
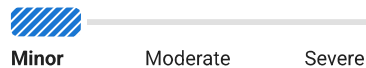

Event 3

12/19/2025

Accident reported: minor to moderate damage

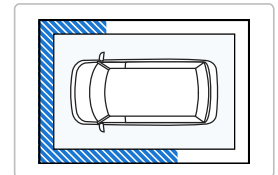
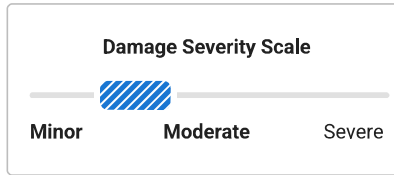

Event 4

01/06/2026

TOTAL LOSS VEHICLE



Recent Service Highlights

Key services performed in the last 12 months

Service	Comments	Date
Oil	✓ Oil and filter changed	08/02/2025
<div style="border: 1px solid #00aaff; border-radius: 10px; padding: 5px; display: inline-block;"> This car has been recently serviced. That's a good thing! </div>		



History-Based Value Report

\$3,600

CARFAX Retail Value

History events affecting this vehicle's value

- 1-Owner Vehicle
- Service History
- Personal Vehicle
- Salvage Brand



Additional History

Not all accidents / issues are reported to CARFAX

Owner 1

Total Loss

Total Loss Reported: 01/06/2026.

Total Loss Reported

Structural Damage

CARFAX recommends that you have this vehicle inspected by a collision repair specialist.

✓ No Issues Reported

Airbag Deployment

No airbag deployment reported to CARFAX.

✓ No Issues Reported

Odometer Check

No indication of an odometer rollback.

✓ No Issues Indicated

Accident / Damage

DMV title problems reported. Accidents reported: 11/27/2015, 05/02/2023, and 12/19/2025.

Severe Damage

Manufacturer Recall



No open recalls reported to CARFAX.







✓ No Recalls Reported

Basic Warranty Original manufacturer warranty likely voided by manufacturer.	Warranty Voided
--	------------------------

CARFAX Title History	Owner 1
Damage Brands Salvage Junk Rebuilt Fire Flood Hail Lemon	Alert! Problem Found
Odometer Brands Not Actual Mileage Exceeds Mechanical Limits	No Problem
 ALERT! - Severe problems were reported by a state Department of Motor Vehicles (DMV). This vehicle does not qualify for the CARFAX Buyback Guarantee.	



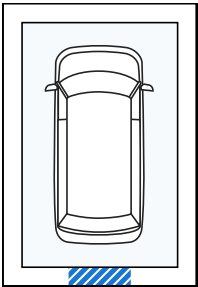





CARFAX Ownership History The number of owners is estimated	Owner 1
Year purchased	2014
Type of owner	Personal
Estimated length of ownership	11 yrs. 5 mo.
Owned in the following states/provinces	New York
Estimated miles driven per year	18,379/yr
Last reported odometer reading	203,129





CARFAX Detailed History			
 Owner 1 Purchased: 2014		Personal Vehicle 18,379 mi/yr	
Date	Mileage	Source	Comments
06/24/2014	7	Friendly Honda Poughkeepsie, NY 845-454-2400 friendlyhonda.net ★ 4.8 / 5.0 1,261 Verified Reviews ❤️ 1,242 Customer Favorites	Vehicle offered for sale
06/24/2014		Friendly Honda Poughkeepsie, NY 845-454-2400 friendlyhonda.net ★ 4.8 / 5.0 1,261 Verified Reviews ❤️ 1,242 Customer Favorites	 Vehicle serviced - Pre-delivery inspection completed
07/17/2014	124	Saratoga Honda Saratoga Springs, NY 518-587-9300 saratogahonda.com ★ 4.1 / 5.0 14 Verified Reviews	Vehicle sold
07/17/2014		New York Inspection Station	Passed safety inspection - Passed emissions inspection
07/17/2014		New York Motor Vehicle Dept. Clifton Park, NY	Registration issued or renewed - Titled or registered as personal vehicle - Passed safety inspection
08/19/2014		New York	Title issued or updated

		Motor Vehicle Dept. Clifton Park, NY		<ul style="list-style-type: none"> - Registration issued or renewed - First owner reported - Titled or registered as personal vehicle - Loan or lien reported - Passed safety inspection
11/18/2014	7,045	Saratoga Honda Saratoga Springs, NY 518-587-9300 saratogahonda.com ★ 4.1 / 5.0 14 Verified Reviews		Vehicle serviced <ul style="list-style-type: none"> - Maintenance reminder reset - Oil and filter changed - Tires rotated
04/23/2015	12,647	Mohawk Honda Schenectady, NY 518-370-4911 mohawkhonda.com ★ 4.8 / 5.0 3,634 Verified Reviews ♥ 30,686 Customer Favorites		Vehicle serviced
05/26/2015	14,025	Saratoga Honda Saratoga Springs, NY 518-587-9300 saratogahonda.com ★ 4.1 / 5.0 14 Verified Reviews		Vehicle serviced <ul style="list-style-type: none"> - Maintenance reminder reset - Oil and filter changed - Tire condition and pressure checked - Tires rotated
07/27/2015	17,026	New York Inspection Station		Passed safety inspection <ul style="list-style-type: none"> - Emissions inspection performed
10/07/2015	20,201	Mohawk Honda Schenectady, NY 518-370-4911 mohawkhonda.com ★ 4.8 / 5.0 3,634 Verified Reviews ♥ 30,686 Customer Favorites		Vehicle serviced <ul style="list-style-type: none"> - Maintenance inspection completed - Battery/charging system checked - Oil and filter changed - Tire condition and pressure checked - Tire pressure monitoring system reset - Tires rotated
11/27/2015		Damage Report		Accident reported: minor damage with another motor vehicle <ul style="list-style-type: none"> - Damage to rear <div data-bbox="836 1225 1240 1830" style="border: 1px solid gray; padding: 10px; margin-top: 10px;"> <p style="text-align: center;">Damage Severity Scale</p> <div style="display: flex; align-items: center; justify-content: center;">  </div> <div style="display: flex; justify-content: space-between; width: 100%;"> Minor Moderate Severe </div> <p style="text-align: center;">Damage Location</p> <div style="text-align: center;">  </div> </div>
01/05/2016	23,961	Mohawk Honda Schenectady, NY 518-370-4911 mohawkhonda.com ★ 4.8 / 5.0 3,634 Verified Reviews ♥ 30,686 Customer Favorites		Vehicle serviced

CARFAX HAS THE MOST ACCIDENT & DAMAGE INFORMATION

04/11/2016	27,324	Mohawk Honda Schenectady, NY 518-370-4911 mohawkhonda.com ★ 4.8 / 5.0 3,634 Verified Reviews ♥ 30,686 Customer Favorites		Vehicle serviced - Maintenance inspection completed - Air filter replaced - Oil and filter changed - Tires rotated
07/29/2016	32,688	Valvoline Instant Oil Change Clifton Park, NY 518-383-4818 vioc.com ★ 4.7 / 5.0 280 Verified Reviews ♥ 169 Customer Favorites		Vehicle serviced - Emissions inspection performed
07/29/2016		New York Inspection Station		Passed safety inspection - Passed emissions inspection
08/27/2016	34,108	Saratoga Honda Saratoga Springs, NY 518-587-9300 saratogahonda.com ★ 4.1 / 5.0 14 Verified Reviews		Vehicle serviced - Maintenance inspection completed - Oil and filter changed
09/22/2016		New York Motor Vehicle Dept. Clifton Park, NY		Registration issued or renewed - Titled or registered as personal vehicle - Passed safety inspection
01/07/2017	40,973	Saratoga Honda Saratoga Springs, NY 518-587-9300 saratogahonda.com ★ 4.1 / 5.0 14 Verified Reviews		Vehicle serviced - Maintenance inspection completed - Oil and filter changed
06/09/2017		Saratoga Honda Saratoga Springs, NY 518-587-9300 saratogahonda.com ★ 4.1 / 5.0 14 Verified Reviews		Vehicle serviced - Maintenance inspection completed - Emissions inspection performed - Oil and filter changed - Safety inspection performed - Tires rotated
06/09/2017	47,593	New York Inspection Station		Passed safety inspection - Passed emissions inspection
10/31/2017	56,300	Mohawk Honda Schenectady, NY 518-370-4911 mohawkhonda.com ★ 4.8 / 5.0 3,634 Verified Reviews ♥ 30,686 Customer Favorites		Vehicle serviced - Maintenance inspection completed - Oil and filter changed - Transmission fluid changed
04/14/2018	63,440	Service Facility ★ 4.6 / 5.0 11 Verified Reviews ♥ 1 Customer Favorite		Vehicle serviced - Tire(s) replaced
04/27/2018	63,963	Saratoga Honda Saratoga Springs, NY 518-587-9300 saratogahonda.com ★ 4.1 / 5.0 14 Verified Reviews		Vehicle serviced - Maintenance inspection completed - Oil and filter changed - Tires rotated
06/16/2018	67,174	New York Inspection Station		Passed safety inspection - Passed emissions inspection
08/29/2018	71,850	Saratoga Honda Saratoga Springs, NY 518-587-9300 saratogahonda.com ★ 4.1 / 5.0 14 Verified Reviews		Vehicle serviced - Maintenance inspection completed - Oil and filter changed
11/20/2018		New York		Registration issued or renewed







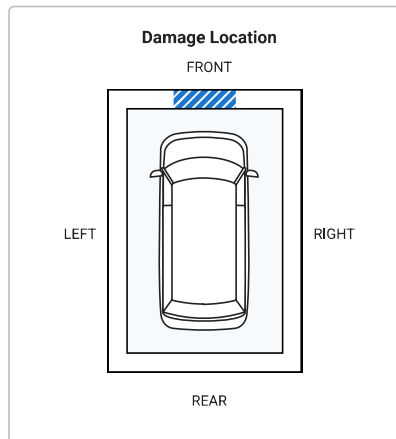
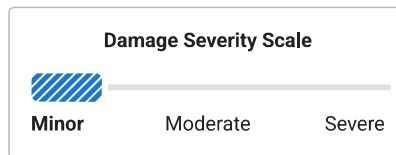

		Motor Vehicle Dept. Clifton Park, NY		- Titled or registered as personal vehicle - Passed safety inspection
01/05/2019	78,296	Valvoline Instant Oil Change Clifton Park, NY 518-383-4818 vioc.com ★ 4.7 / 5.0 280 Verified Reviews ♥ 169 Customer Favorites		Vehicle serviced - Air filter replaced - Oil and filter changed
05/18/2019	88,501	Valvoline Instant Oil Change Clifton Park, NY 518-371-2013 vioc.com ★ 4.7 / 5.0 154 Verified Reviews		Vehicle serviced - Oil and filter changed
06/22/2019		Valvoline Instant Oil Change Clifton Park, NY 518-371-2013 vioc.com ★ 4.7 / 5.0 154 Verified Reviews		Vehicle serviced - Emissions inspection performed
06/22/2019		New York Inspection Station		Passed safety inspection - Passed emissions inspection
06/23/2019		Monro Auto Service & Tire Centers Clifton Park, NY 518-383-9007 monro.com ★ 4.4 / 5.0 57 Verified Reviews		Vehicle serviced - Maintenance inspection completed - Recommended maintenance performed - Tire(s) balanced - Tire(s) replaced
09/14/2019	92,285	Valvoline Instant Oil Change Clifton Park, NY 518-371-2013 vioc.com ★ 4.7 / 5.0 154 Verified Reviews		Vehicle serviced - Oil and filter changed - Tires rotated
09/12/2020	107,708	Valvoline Instant Oil Change Clifton Park, NY 518-371-2013 vioc.com ★ 4.7 / 5.0 154 Verified Reviews		Vehicle serviced - Drain plug gasket replaced - Oil and filter changed - Vehicle washed/detailed
10/15/2020	108,841	Sam's Club Tire & Battery Center Latham, NY 518-783-1481 https://www.samsclub.com ★ 4.6 / 5.0 11 Verified Reviews ♥ 1 Customer Favorite		Vehicle serviced - Tire(s) replaced
10/22/2020	108,960	New York Inspection Station		Passed safety inspection - Passed emissions inspection
10/22/2020		New York Motor Vehicle Dept. Clifton Park, NY		Registration issued or renewed - Titled or registered as personal vehicle - Passed safety inspection
04/03/2021	114,234	Valvoline Instant Oil Change Clifton Park, NY 518-371-2013 vioc.com ★ 4.7 / 5.0 154 Verified Reviews		Vehicle serviced - Drain plug gasket replaced - Oil and filter changed
08/12/2021	121,766	Valvoline Instant Oil Change Clifton Park, NY 518-383-4818 vioc.com ★ 4.7 / 5.0 280 Verified Reviews ♥ 169 Customer Favorites		Vehicle serviced - Air filter replaced - Oil and filter changed

10/20/2021	126,266	New York Inspection Station		Passed safety inspection - Passed emissions inspection
11/20/2021	128,357	Valvoline Instant Oil Change Clifton Park, NY 518-371-2013 vioc.com ★ 4.7 / 5.0 154 Verified Reviews		Vehicle serviced - Oil and filter changed
03/18/2022	135,189	Valvoline Instant Oil Change Clifton Park, NY 518-383-4818 vioc.com ★ 4.7 / 5.0 280 Verified Reviews ♥ 169 Customer Favorites		Vehicle serviced - Drain plug gasket replaced - Oil and filter changed
06/17/2022	143,040	Valvoline Instant Oil Change Clifton Park, NY 518-371-2013 vioc.com ★ 4.7 / 5.0 154 Verified Reviews		Vehicle serviced - Oil and filter changed
09/15/2022		New York Motor Vehicle Dept. Clifton Park, NY		Registration issued or renewed - Titled or registered as personal vehicle - Passed safety inspection
10/28/2022	150,490	Valvoline Instant Oil Change Clifton Park, NY 518-383-4818 vioc.com ★ 4.7 / 5.0 280 Verified Reviews ♥ 169 Customer Favorites		Vehicle serviced - Air filter replaced - Cabin air filter replaced/cleaned - Emissions inspection performed - Oil and filter changed
10/28/2022		New York Inspection Station		Passed safety inspection - Passed emissions inspection
02/25/2023	157,941	Jiffy Lube Halfmoon, NY 518-373-0602 jiffylube.com/ ★ 4.8 / 5.0 16 Verified Reviews		Vehicle serviced - Fluids checked - Oil and filter changed - Tires rotated

05/02/2023 Damage Report **Accident reported: minor damage with another motor vehicle**
- Damage to front



CARFAX HAS THE MOST ACCIDENT & DAMAGE INFORMATION

06/23/2023	165,082	Valvoline Instant Oil Change Clifton Park, NY 518-383-4818 vioc.com ★ 4.7 / 5.0 280 Verified Reviews ♥ 169 Customer Favorites		Vehicle serviced - Drain plug gasket replaced - Oil and filter changed
10/14/2023	171,141	Jiffy Lube Halfmoon, NY 518-373-0602 jiffylube.com/ ★ 4.8 / 5.0 16 Verified Reviews		Vehicle serviced - Emissions or safety inspection performed - Safety inspection performed
10/14/2023		New York Inspection Station		Passed safety inspection - Passed emissions inspection
11/25/2023	173,333	Valvoline Instant Oil Change Clifton Park, NY 518-371-2013 vioc.com ★ 4.7 / 5.0 154 Verified Reviews		Vehicle serviced - Oil and filter changed
04/06/2024	181,472	Valvoline Instant Oil Change Clifton Park, NY 518-383-4818 vioc.com ★ 4.7 / 5.0 280 Verified Reviews ♥ 169 Customer Favorites		Vehicle serviced - Oil and filter changed
08/10/2024	188,859	Valvoline Instant Oil Change Clifton Park, NY 518-383-4818 vioc.com ★ 4.7 / 5.0 280 Verified Reviews ♥ 169 Customer Favorites		Vehicle serviced - Oil and filter changed
09/20/2024		New York Motor Vehicle Dept. Clifton Park, NY		Registration issued or renewed - Titled or registered as personal vehicle - Passed safety inspection
10/27/2024	191,740	Pep Boys Albany, NY 518-446-1660 pepboys.com ★ 4.6 / 5.0 197 Verified Reviews ♥ 151 Customer Favorites		Vehicle serviced - Maintenance inspection completed - Emissions inspection performed - Tire pressure monitoring system serviced - Tire(s) balanced - Tire(s) mounted - Tire(s) replaced
10/27/2024		New York Inspection Station		Passed safety inspection - Passed emissions inspection
02/22/2025	196,010	Valvoline Instant Oil Change Clifton Park, NY 518-383-4818 vioc.com ★ 4.7 / 5.0 280 Verified Reviews ♥ 169 Customer Favorites		Vehicle serviced - Drain plug gasket replaced - Oil and filter changed
08/02/2025	203,129	Valvoline Instant Oil Change Clifton Park, NY 518-383-4818 vioc.com ★ 4.7 / 5.0 280 Verified Reviews ♥ 169 Customer Favorites		Vehicle serviced - Air filter replaced - Oil and filter changed
12/19/2025		Damage Report		Accident reported: minor to moderate damage - Damage to front - Damage to left front - Damage to left side

- Damage to right front

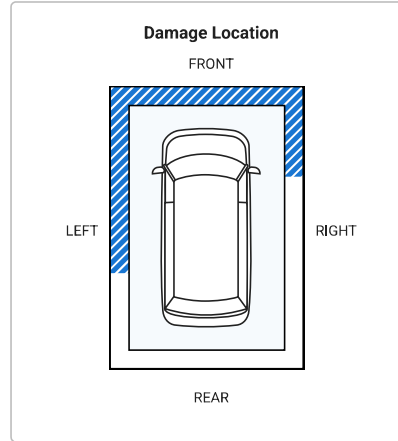
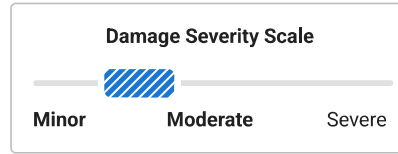

CARFAX HAS THE MOST ACCIDENT & DAMAGE INFORMATION

01/06/2026	Damage Report		TOTAL LOSS VEHICLE
<div style="border: 1px solid blue; padding: 5px;"> <p>There are many reasons an insurance company will declare a vehicle a total loss. Have this vehicle inspected by a qualified technician before you buy. Learn More</p> </div>			
01/06/2026	New York Motor Vehicle Dept.		Title or registration issued to insurance company
01/06/2026	New York Motor Vehicle Dept. Albany, NY		SALVAGE TITLE/CERTIFICATE ISSUED
01/07/2026	Damage Report		SALVAGE TITLE/CERTIFICATE ISSUED

Have Questions? Consumers, please visit our Help Center at www.carfax.com. Dealers or Subscribers, please visit our Help Center at www.carfaxonline.com.

CARFAX Glossary

Accident Indicator

CARFAX receives information about accidents in all 50 states, the District of Columbia and Canada.

Not every accident is reported to CARFAX. As details about the accident become available, those additional details are added to the CARFAX Vehicle History Report. CARFAX recommends that you have this vehicle inspected by a qualified mechanic.

- According to the National Safety Council, Injury Facts, 2021 edition, 5% of the 276 million registered vehicles in the U.S. were involved in an accident in 2019. Over 77% of these were considered minor or moderate.
- This CARFAX Vehicle History Report is based only on information supplied to CARFAX and available as of 5/25/26 at 8:15:11 AM (CDT). Other information about this vehicle, including problems, may not have been reported to CARFAX. Use this report as one important tool, along with a vehicle inspection and test drive, to make a better decision about your next used car.

Damage Indicator

Damage can be a result of many different types of events. Examples include contact with objects (other cars, trees, traffic signs, road debris, etc), vandalism, or weather-related events. Not every damage event is reported to CARFAX. As details about the damage event become available, those additional details are added to the CARFAX Vehicle History Report. CARFAX recommends that you have this vehicle inspected by a qualified mechanic.

- This CARFAX Vehicle History Report is based only on information supplied to CARFAX and available as of 5/25/26 at 8:15:11 AM (CDT). Other information about this vehicle, including problems, may not have been reported to CARFAX. Use this report as one important tool, along with a vehicle inspection and test drive, to make a better decision about your next used car.

Damage Severity

Damage events result in one of the following severity levels:

- Minor: Generally, minor damage is cosmetic (including dents or scratches), may only require reconditioning, and typically does not compromise a vehicle's operation and/or safety.
- Moderate: Moderate damage may affect multiple components of the vehicle and may impair the vehicle's operation and/or safety.

- Severe: Severe damage usually affects multiple components of the vehicle and is likely to compromise the vehicle's operation and/or safety.

CARFAX recommends getting a pre-purchase inspection at a certified collision repair facility.

First Owner

When the first owner(s) obtains a title from a Department of Motor Vehicles as proof of ownership.

Ownership History

CARFAX defines an owner as an individual or business that possesses and uses a vehicle. Not all title transactions represent changes in ownership. To provide estimated number of owners, CARFAX proprietary technology analyzes all the events in a vehicle history. Estimated ownership is available for vehicles manufactured after 1991 and titled solely in the US including Puerto Rico. Dealers sometimes opt to take ownership of a vehicle and are required to in the following states: Maine, Massachusetts, New Jersey, Ohio, Oklahoma, Pennsylvania and South Dakota. Please consider this as you review a vehicle's estimated ownership history.

Salvage Title



A Salvage Title is issued on a vehicle damaged to the extent that the cost of repairing the vehicle exceeds approximately 75% of its pre-damage value. This damage threshold may vary by state. Some states treat Junk titles the same as Salvage but the majority use this title to indicate that a vehicle is not road worthy and cannot be titled again in that state. The following eleven states also use Salvage titles to identify stolen vehicles - AZ, FL, GA, IL, MD, MN, NJ, NM, NY, OK and OR.

Title Issued

A state issues a title to provide a vehicle owner with proof of ownership. Each title has a unique number. Each title or registration record on a CARFAX report does not necessarily indicate a change in ownership. In Canada, a registration and bill of sale are used as proof of ownership.

Total Loss Vehicle

An insurance or fleet company declares a vehicle a total loss when a claim exceeds approximately 75% of its pre-damage value or if the vehicle is stolen and not recovered. This damage threshold varies by company. These companies typically take possession and obtain the title. Not all total loss vehicles result in a DMV-reported branded title. This may occur when an insurance company's definition of a total loss is different than the state DMV's definition for a branded title or when the owner of the vehicle is a self-insured company, like a fleet or rental company.

Follow Us:  facebook.com/CARFAX  [@CARFAXinc](https://twitter.com/CARFAXinc)  [About CARFAX](#)

CARFAX DEPENDS ON ITS SOURCES FOR THE ACCURACY AND RELIABILITY OF ITS INFORMATION. THEREFORE, NO RESPONSIBILITY IS ASSUMED BY CARFAX OR ITS AGENTS FOR ERRORS OR OMISSIONS IN THIS REPORT. CARFAX FURTHER EXPRESSLY DISCLAIMS ALL WARRANTIES, EXPRESS OR IMPLIED, INCLUDING ANY IMPLIED WARRANTIES OF MERCHANTABILITY OR FITNESS FOR A PARTICULAR PURPOSE.

© 2026 CARFAX, Inc., part of S&P Global. All rights reserved.
5/25/26 8:15:11 AM (CDT)

I have reviewed and received a copy of the CARFAX Vehicle History Report for this 2014 HONDA ODYSSEY vehicle (VIN: 5FNRL5H48EB121564), which is based on information supplied to CARFAX and available as of 5/25/26 at 9:15 AM (EDT).

Customer Signature

Date

Dealer Signature

Date