



Report

US \$44.99

2022 Mazda CX-5 2.5 S Premium

73,804 mi | VIN: JM3KFBDMXN1626440 |

4 Door Wagon/Sport Utility | 2.5L I4 F DOHC 16V | Gasoline | All wheel drive

CARFAX HAS THE MOST ACCIDENT & DAMAGE INFORMATION



BRANDED TITLE

Salvage

CARFAX VALUE \$15,010

9 Service History Records

3 Previous Owners

Personal Vehicle

Last Owned in California

25 Detailed Records Available

This CARFAX Vehicle History Report is based only on information supplied to CARFAX and available as of 5/27/26 at 7:50:22 AM (CDT). Other information about this vehicle, including problems, may not have been reported to CARFAX. Use this report as one important tool, along with a vehicle inspection and test drive, to make a better decision about your next used car.



Accident / Damage History

Not all accidents / issues are reported to CARFAX

Event 1

08/23/2024

Damage reported: minor damage

Damage Severity Scale

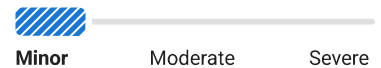

Event 2

08/15/2025

Damage reported: minor damage

Damage Severity Scale

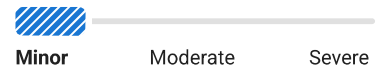

Event 3

03/23/2026

TOTAL LOSS VEHICLE

- Vehicle declared a total loss by an insurance company
- Collision damage reported

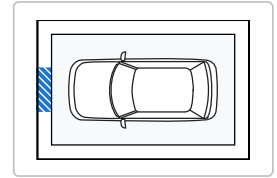

Event 4

03/25/2026

Damage reported: moderate damage

Damage Severity Scale

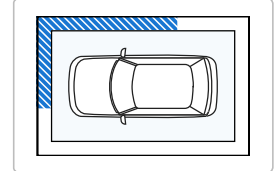

CARFAX History-Based Value Report

\$15,010

CARFAX Retail Value

History events affecting this vehicle's value

- Service History
- Personal Vehicle
- Salvage Brand

CARFAX Additional History

Not all accidents / issues are reported to CARFAX

	Owner 1	Owner 2	Owner 3
Total Loss Total Loss Reported: 03/23/2026.	<input checked="" type="checkbox"/> No Issues Reported	Total Loss Reported	No New Issues Reported
Structural Damage CARFAX recommends that you have this vehicle inspected by a collision repair specialist.	<input checked="" type="checkbox"/> No Issues Reported	<input checked="" type="checkbox"/> No Issues Reported	<input checked="" type="checkbox"/> No Issues Reported
Airbag Deployment No airbag deployment reported to CARFAX.	<input checked="" type="checkbox"/> No Issues Reported	<input checked="" type="checkbox"/> No Issues Reported	<input checked="" type="checkbox"/> No Issues Reported
Odometer Check No indication of an odometer rollback.	<input checked="" type="checkbox"/> No Issues Indicated	<input checked="" type="checkbox"/> No Issues Indicated	<input checked="" type="checkbox"/> No Issues Indicated
Accident / Damage DMV title problems reported. Damage reported: 08/23/2024, 08/15/2025, and 03/25/2026. Accident reported: 03/23/2026.	<input checked="" type="checkbox"/> No Issues Reported	Severe Damage	Severe Damage
Manufacturer Recall No open recalls reported to CARFAX.	<input checked="" type="checkbox"/> No Recalls Reported	<input checked="" type="checkbox"/> No Recalls Reported	<input checked="" type="checkbox"/> No Recalls Reported
Basic Warranty Original manufacturer warranty likely voided by manufacturer.	<input checked="" type="checkbox"/> Warranty Active	Warranty Voided	Warranty Voided





CARFAX Title History



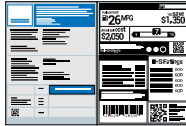

	Owner 1	Owner 2	Owner 3
Damage Brands Salvage Junk Rebuilt Fire Flood Hail Lemon	No Problem	Alert! Problem Found	Alert! Problem Found
Odometer Brands Not Actual Mileage Exceeds Mechanical Limits	No Problem	No Problem	No Problem



ALERT! - Severe problems were reported by a state Department of Motor Vehicles (DMV). This vehicle does not qualify for the CARFAX Buyback Guarantee.

CARFAX Ownership History <small>The number of owners is estimated</small>	Owner 1	Owner 2	Owner 3
Year purchased	2022	2024	2026
Type of owner	Personal	Personal	Personal
Estimated length of ownership	1 yr. 7 mo.	2 years	4 days
Owned in the following states/provinces	Texas	California	California
Estimated miles driven per year	7,278/yr	31,954/yr	--
Last reported odometer reading	10,928	57,879	73,804

CARFAX Detailed History			
Owner 1 Purchased: 2022			Personal Vehicle 7,278 mi/yr
Date	Mileage	Source	Comments
Not Reported		Mazda Motor of America, Inc.	Vehicle manufactured and shipped to original dealer Original Window Sticker 
06/24/2022		Viva Mazda El Paso, TX 915-775-6600 https://vivamazda.com/ ★ 4.5 / 5.0 119 Verified Reviews	Vehicle offered for sale
07/26/2022		Viva Mazda El Paso, TX 915-775-6600 https://vivamazda.com/ ★ 4.5 / 5.0 119 Verified Reviews	 Vehicle serviced - Pre-delivery inspection completed - Safety inspection performed
08/01/2022	4	Viva Mazda El Paso, TX 915-775-6600 https://vivamazda.com/ ★ 4.5 / 5.0 119 Verified Reviews	Vehicle sold
09/13/2022	10	Viva Mazda El Paso, TX 915-775-6600 https://vivamazda.com/ ★ 4.5 / 5.0 119 Verified Reviews	 Vehicle serviced - Vehicle washed/detailed
09/16/2022		Texas Motor Vehicle Dept. El Paso, TX Title #07100644810143908	Title issued or updated - First owner reported - Titled or registered as personal vehicle - Loan or lien reported - Vehicle color noted as Black
10/20/2022	2,670	Mazda of Claremont Claremont, CA	 Vehicle serviced - Maintenance inspection completed

		909-451-5100 mazdaofclaremont.com ★ 4.6 / 5.0 185 Verified Reviews ❤️ 3,268 Customer Favorites		- Battery/charging system checked - Battery replaced - Body electrical system checked - No-start/hard start condition checked - Tire condition and pressure checked
11/19/2022	3,404	Mazda of Claremont Claremont, CA 909-451-5100 mazdaofclaremont.com ★ 4.6 / 5.0 185 Verified Reviews ❤️ 3,268 Customer Favorites		Vehicle serviced - Maintenance inspection completed - Oil and filter changed - Tire condition and pressure checked
06/03/2023	7,486	Mazda of Claremont Claremont, CA 909-451-5100 mazdaofclaremont.com ★ 4.6 / 5.0 185 Verified Reviews ❤️ 3,268 Customer Favorites		Vehicle serviced - Maintenance inspection completed - 5,000 mile service performed - Oil and filter changed - Tire condition and pressure checked
06/30/2023	7,521	Mazda of Claremont Claremont, CA 909-451-5100 mazdaofclaremont.com ★ 4.6 / 5.0 185 Verified Reviews ❤️ 3,268 Customer Favorites		Vehicle serviced - Maintenance inspection completed - Tire condition and pressure checked
11/14/2023	8,987	Mazda of Claremont Claremont, CA 909-451-5100 mazdaofclaremont.com ★ 4.6 / 5.0 185 Verified Reviews ❤️ 3,268 Customer Favorites		Vehicle serviced - Maintenance inspection completed - Oil and filter changed - Tire condition and pressure checked
03/14/2024	10,924	California Inspection Station		Passed emissions inspection
03/17/2024	10,928	California Motor Vehicle Dept. Carson, CA		Odometer reading reported
04/13/2024		Texas Motor Vehicle Dept. El Paso, TX Title #28695345392013071		Title issued or updated - Loan or lien released - Vehicle color noted as Black

 **Owner 2**
Purchased: 2024

Personal Vehicle
31,954 mi/yr

Date	Mileage	Source	Comments
05/01/2024		California Motor Vehicle Dept. Carson, CA	Title issued or updated - New owner reported
07/08/2024	20,759	Jiffy Lube Long Beach, CA 562-427-1918 jiffylube.com/ ★ 4.7 / 5.0 10 Verified Reviews ❤️ 10 Customer Favorites	 Vehicle serviced - Maintenance inspection completed
08/23/2024		Damage Report	Damage reported: minor damage

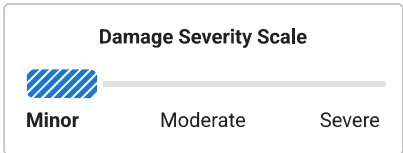

08/15/2025

Damage Report

Damage reported: minor damage

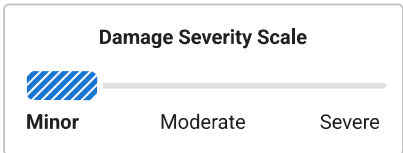

09/05/2025

57,879

Jiffy Lube
 Long Beach, CA
 562-427-1918
 jiffylube.com/
 ★ 4.7 / 5.0 10 Verified Reviews
 ❤️ 10 Customer Favorites



Vehicle serviced
 - Maintenance inspection completed

03/23/2026

Damage Report



TOTAL LOSS VEHICLE
 - Vehicle declared a total loss by an insurance company
 - Collision damage reported
 - Damage to front

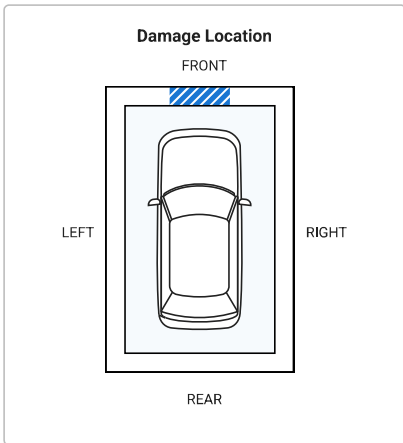

There are many reasons an insurance company will declare a vehicle a total loss. Have this vehicle inspected by a qualified technician before you buy. [Learn More](#)

**CARFAX HAS THE MOST
 ACCIDENT & DAMAGE
 INFORMATION**

03/25/2026

Damage Report



Damage reported: moderate damage
 - Damage to right front
 - Damage to right side
 - Damage to front

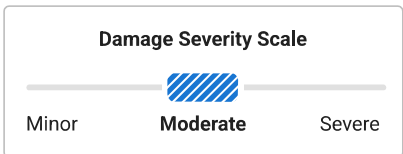

**CARFAX HAS THE MOST
 ACCIDENT & DAMAGE
 INFORMATION**

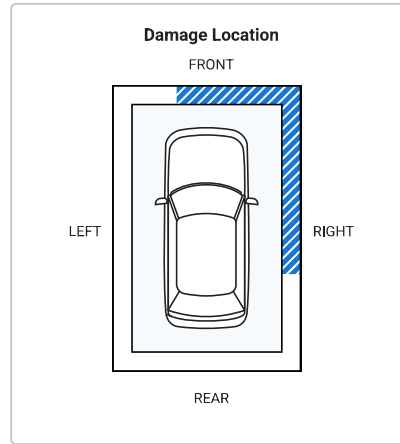

05/15/2026	California Motor Vehicle Dept. Carson, CA	Title issued or updated - Loan or lien reported
05/21/2026	Damage Report	 SALVAGE TITLE/CERTIFICATE ISSUED

 **Owner 3**
Purchased: 2026 Personal Vehicle

Date	Mileage	Source	Comments
05/21/2026	73,804	California Motor Vehicle Dept. Sacramento, CA	 New owner reported - SALVAGE TITLE/CERTIFICATE ISSUED
05/25/2026		Auto Auction	Vehicle sold

Have Questions? Consumers, please visit our Help Center at www.carfax.com. Dealers or Subscribers, please visit our Help Center at www.carfaxonline.com.

CARFAX Glossary

Accident Indicator

CARFAX receives information about accidents in all 50 states, the District of Columbia and Canada.

Not every accident is reported to CARFAX. As details about the accident become available, those additional details are added to the CARFAX Vehicle History Report. CARFAX recommends that you have this vehicle inspected by a qualified mechanic.

- According to the National Safety Council, Injury Facts, 2021 edition, 5% of the 276 million registered vehicles in the U.S. were involved in an accident in 2019. Over 77% of these were considered minor or moderate.
- This CARFAX Vehicle History Report is based only on information supplied to CARFAX and available as of 5/27/26 at 7:50:22 AM (CDT). Other information about this vehicle, including problems, may not have been reported to CARFAX. Use this report as one important tool, along with a vehicle inspection and test drive, to make a better decision about your next used car.

Damage Indicator

Damage can be a result of many different types of events. Examples include contact with objects (other cars, trees, traffic signs, road debris, etc), vandalism, or weather-related events. Not every damage event is reported to CARFAX. As details about the damage event become available, those additional details are added to the CARFAX Vehicle History Report. CARFAX recommends that you have this vehicle inspected by a qualified mechanic.

- This CARFAX Vehicle History Report is based only on information supplied to CARFAX and available as of 5/27/26 at 7:50:22 AM (CDT). Other information about this vehicle, including problems, may not have been reported to CARFAX. Use this report as one important tool, along with a vehicle inspection and test drive, to make a better decision about your next used car.

Damage Severity

Damage events result in one of the following severity levels:

- Minor: Generally, minor damage is cosmetic (including dents or scratches), may only require reconditioning, and typically does not compromise a vehicle's operation and/or safety.
- Moderate: Moderate damage may affect multiple components of the vehicle and may impair the vehicle's operation and/or safety.
- Severe: Severe damage usually affects multiple components of the vehicle and is likely to compromise the vehicle's operation and/or safety.

CARFAX recommends getting a pre-purchase inspection at a certified collision repair facility.

First Owner

When the first owner(s) obtains a title from a Department of Motor Vehicles as proof of ownership.

New Owner Reported

When a vehicle is sold to a new owner, the Title must be transferred to the new owner(s) at a Department of Motor Vehicles.

Ownership History

CARFAX defines an owner as an individual or business that possesses and uses a vehicle. Not all title transactions represent changes in ownership. To provide estimated number of owners, CARFAX proprietary technology analyzes all the events in a vehicle history. Estimated ownership is available for vehicles manufactured after 1991 and titled solely in the US including Puerto Rico. Dealers sometimes opt to take ownership of a vehicle and are required to in the following states: Maine, Massachusetts, New Jersey, Ohio, Oklahoma, Pennsylvania and South Dakota. Please consider this as you review a vehicle's estimated ownership history.

Salvage Title

A Salvage Title is issued on a vehicle damaged to the extent that the cost of repairing the vehicle exceeds approximately 75% of its pre-damage value. This damage threshold may vary by state. Some states treat Junk titles the same as Salvage but the majority use this title to indicate that a vehicle is not road worthy and cannot be titled again in that state. The following eleven states also use Salvage titles to identify stolen vehicles - AZ, FL, GA, IL, MD, MN, NJ, NM, NY, OK and OR.

Title Issued

A state issues a title to provide a vehicle owner with proof of ownership. Each title has a unique number. Each title or registration record on a CARFAX report does not necessarily indicate a change in ownership. In Canada, a registration and bill of sale are used as proof of ownership.

Total Loss Vehicle

An insurance or fleet company declares a vehicle a total loss when a claim exceeds approximately 75% of its pre-damage value or if the vehicle is stolen and not recovered. This damage threshold varies by company. These companies typically take possession and obtain the title. Not all total loss vehicles result in a DMV-reported branded title. This may occur when an insurance company's definition of a total loss is different than the state DMV's definition for a branded title or when the owner of the vehicle is a self-insured company, like a fleet or rental company.

Follow Us:  facebook.com/CARFAX  [@CARFAXinc](https://twitter.com/CARFAXinc)  [About CARFAX](#)

CARFAX DEPENDS ON ITS SOURCES FOR THE ACCURACY AND RELIABILITY OF ITS INFORMATION. THEREFORE, NO RESPONSIBILITY IS ASSUMED BY CARFAX OR ITS AGENTS FOR ERRORS OR OMISSIONS IN THIS REPORT. CARFAX FURTHER EXPRESSLY DISCLAIMS ALL WARRANTIES, EXPRESS OR IMPLIED, INCLUDING ANY IMPLIED WARRANTIES OF MERCHANTABILITY OR FITNESS FOR A PARTICULAR PURPOSE.

© 2026 CARFAX, Inc., part of S&P Global. All rights reserved.
5/27/26 7:50:22 AM (CDT)

I have reviewed and received a copy of the CARFAX Vehicle History Report for this 2022 MAZDA CX-5 vehicle (VIN: JM3KFBDMXN1626440), which is based on information supplied to CARFAX and available as of 5/27/26 at 8:50 AM (EDT).

Customer Signature

Date

Dealer Signature

Date