



# Report

## 2021 Jeep Cherokee Latitude Lux

67,409 mi | VIN: 1C4PJMMX9MD205518

CARFAX HAS THE MOST ACCIDENT & DAMAGE INFORMATION



BRANDED TITLE

Salvage

10 Service History Records

CARFAX 1-Owner Vehicle

Personal Vehicle

Last Owned in Pennsylvania

27 Detailed Records Available



### Accident / Damage History

Not all accidents / issues are reported to CARFAX

#### Event 1

05/09/2026

#### TOTAL LOSS VEHICLE

-Accident reported  
-Vehicle declared a total loss by an insurance company

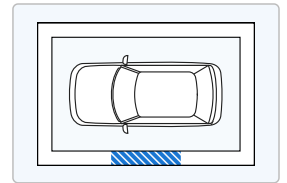

#### Event 2

05/12/2026

#### Damage reported: moderate damage

-Airbag deployed

#### Damage Severity Scale

Minor Moderate Severe

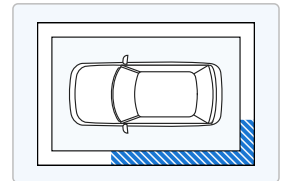

### Additional History

Not all accidents / issues are reported to CARFAX

Owner 1

#### Total Loss

Total Loss Reported: 05/09/2026.

Total Loss Reported



#### Structural Damage





✓ No Issues Reported





CARFAX recommends that you have this vehicle inspected by a collision repair specialist.	
<b>Airbag Deployment</b> Airbag deployment reported: 05/12/2026.	Airbag Deployment
<b>Odometer Check</b> No indication of an odometer rollback.	✔ No Issues Indicated
<b>Accident / Damage</b> DMV title problems reported. Accident reported: 05/09/2026. Damage reported: 05/12/2026.	Severe Damage
<b>Manufacturer Recall</b> No open recalls reported to CARFAX.	✔ No Recalls Reported
<b>Basic Warranty</b> Original manufacturer warranty likely voided by manufacturer.	<b>Warranty Voided</b>

<b>CARFAX Title History</b>	👤 Owner 1
<b>Damage Brands</b> Salvage   Junk   Rebuilt   Fire   Flood   Hail   Lemon	<b>Alert!</b> Problem Found
<b>Odometer Brands</b> Not Actual Mileage   Exceeds Mechanical Limits	No Problem
 <b>ALERT!</b> - Severe problems were reported by a state Department of Motor Vehicles (DMV). This vehicle does not qualify for the CARFAX Buyback Guarantee.	

<b>CARFAX Ownership History</b> The number of owners is estimated	👤 Owner 1
Year purchased	2021
Type of owner	Personal
Estimated length of ownership	5 years
Owned in the following states/provinces	Pennsylvania
Estimated miles driven per year	13,430/yr
Last reported odometer reading	67,409

<b>CARFAX Detailed History</b>			
👤 <b>Owner 1</b> Purchased: 2021		Personal Vehicle 13,430 mi/yr	
Date	Mileage	Source	Comments
Not Reported		FCA US LLC	<b>Original Window Sticker</b> 
04/03/2021	2	Inspection Station	<b>Exempt from emissions inspection</b>
04/05/2021	11	Savage L & B Dodge Chrysler Jeep Robesonia, PA 610-693-5855	 <b>Vehicle serviced</b> -Pre-delivery inspection completed -Brakes checked

		savagechrysler.com ★ <b>4.7 / 5.0</b> 202 Verified Reviews ♥ <b>1,704</b> Customer Favorites		-Emissions or safety inspection performed -Wheel locks installed
06/03/2021	14	Savage L&B Dodge Chrysler Jeep Robesonia, PA 610-693-5855 savagechrysler.com/ ★ <b>4.7 / 5.0</b> 202 Verified Reviews ♥ <b>1,704</b> Customer Favorites		<b>Vehicle sold</b>
06/03/2021		Pennsylvania Motor Vehicle Dept.		<b>Vehicle purchase reported</b> -Titled or registered as personal vehicle
06/17/2021		Pennsylvania Motor Vehicle Dept. Blandon, PA Title #8346201301 MA		<b>Title issued or updated</b> -First owner reported -Loan or lien reported
07/15/2021	1,053	Savage L & B Dodge Chrysler Jeep Robesonia, PA 610-693-5855 savagechrysler.com ★ <b>4.7 / 5.0</b> 202 Verified Reviews ♥ <b>1,704</b> Customer Favorites		<b>Vehicle serviced</b> -Maintenance inspection completed -Alignment performed
10/18/2021	4,312	Savage 61 Dodge Reading, PA 610-916-6100 savagedodge.net/ ★ <b>4.8 / 5.0</b> 254 Verified Reviews ♥ <b>111</b> Customer Favorites		<b>Vehicle serviced</b> -Maintenance inspection completed -Oil and filter changed
03/17/2022	8,956	Savage 61 Dodge Reading, PA 610-916-6100 savagedodge.net/ ★ <b>4.8 / 5.0</b> 254 Verified Reviews ♥ <b>111</b> Customer Favorites		<b>Vehicle serviced</b> -Maintenance inspection completed -Brakes checked -Emissions inspection performed -Emissions or safety inspection performed -Oil and filter changed -Safety inspection performed -Tires rotated
03/17/2022		Inspection Station		<b>Passed emissions inspection</b>
05/27/2022		Pennsylvania Motor Vehicle Dept. Blandon, PA Title #8346201301 MA		<b>Registration issued or renewed</b>
09/06/2022	14,022	Savage 61 Dodge Reading, PA 610-916-6100 savagedodge.net/ ★ <b>4.8 / 5.0</b> 254 Verified Reviews ♥ <b>111</b> Customer Favorites		<b>Vehicle serviced</b> -Maintenance inspection completed -Oil and filter changed -Tires rotated
11/17/2022	16,634	Savage 61 Dodge Reading, PA 610-916-6100 savagedodge.net/ ★ <b>4.8 / 5.0</b> 254 Verified Reviews ♥ <b>111</b> Customer Favorites		<b>Vehicle serviced</b>

02/24/2023	21,446	Savage 61 Dodge Reading, PA 610-916-6100 savagedodge.net/ ★ <b>4.8 / 5.0</b> 254 Verified Reviews ♥ <b>111</b> Customer Favorites		<b>Vehicle serviced</b> -Oil and filter changed -Tires rotated
02/24/2023		Inspection Station		<b>Passed emissions inspection</b>
04/10/2023		Pennsylvania Motor Vehicle Dept. Blandon, PA Title #8346201301 MA		<b>Registration issued or renewed</b>
05/15/2023	26,697	Savage 61 Dodge Reading, PA 610-916-6100 savagedodge.net/ ★ <b>4.8 / 5.0</b> 254 Verified Reviews ♥ <b>111</b> Customer Favorites		<b>Vehicle serviced</b> -Maintenance inspection completed -Oil and filter changed -Tires rotated
04/26/2024	39,695	Inspection Station		<b>Passed emissions inspection</b>
06/02/2024		Pennsylvania Motor Vehicle Dept. Blandon, PA Title #8346201301 MA		<b>Registration issued or renewed</b>
01/13/2025	49,206	Brubaker Chrysler Jeep Lancaster, PA 717-299-6541 brubakercars.net ★ <b>4.8 / 5.0</b> 322 Verified Reviews ♥ <b>974</b> Customer Favorites		<b>Vehicle serviced</b> -Maintenance inspection completed -Drivability/performance checked
03/28/2025	51,626	Brubaker Chrysler Jeep Lancaster, PA 717-299-6541 brubakercars.net ★ <b>4.8 / 5.0</b> 322 Verified Reviews ♥ <b>974</b> Customer Favorites		<b>Vehicle serviced</b> -Drivability/performance checked
04/11/2025	52,081	Inspection Station		<b>Passed emissions inspection</b>
05/30/2025		Pennsylvania Motor Vehicle Dept. Blandon, PA Title #8346201301 MA		<b>Registration issued or renewed</b>
05/09/2026		Damage Report		<b>TOTAL LOSS VEHICLE</b> -Accident reported -Vehicle declared a total loss by an insurance company -Damage to left side

**CARFAX HAS THE MOST  
ACCIDENT & DAMAGE  
INFORMATION**



There are many reasons an insurance company will declare a vehicle a total loss. Have this vehicle inspected by a qualified technician before you buy. [Learn More](#)

05/12/2026

Damage Report



**Damage reported: moderate damage**

- Damage to left rear
  - Damage to left side
  - Airbag deployed
- [CARFAX Airbag Tips](#)

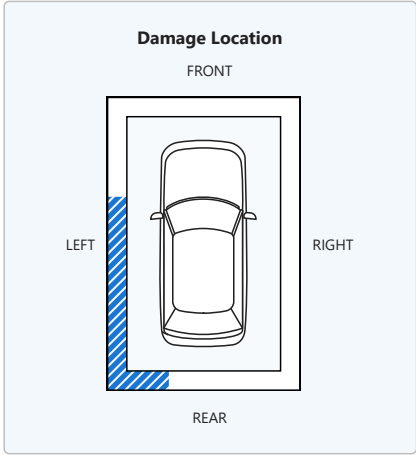
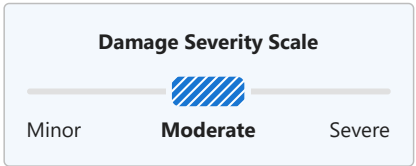

**CARFAX HAS THE MOST ACCIDENT & DAMAGE INFORMATION**

06/09/2026

Pennsylvania  
Motor Vehicle Dept.

**Title or registration issued to insurance company**

06/09/2026

67,409

Pennsylvania  
Motor Vehicle Dept.  
Camp Hill, PA  
Title #8346201301 ER



**SALVAGE TITLE/CERTIFICATE ISSUED**

Have Questions? Consumers, please visit our Help Center at [www.carfax.com](http://www.carfax.com). Dealers or Subscribers, please visit our Help Center at [www.carfaxonline.com](http://www.carfaxonline.com).

**CARFAX Glossary**

**Accident Indicator**

CARFAX receives information about accidents in all 50 states, the District of Columbia and Canada.

Not every accident is reported to CARFAX. As details about the accident become available, those additional details are added to the CARFAX Vehicle History Report. CARFAX recommends that you have this vehicle inspected by a qualified mechanic.

#### Airbag Deployment

Occurs when the driver, passenger or side airbag has been used or deployed during a crash or other incident. If an airbag has been deployed, it must be replaced by a qualified technician. Have this car inspected by a mechanic prior to purchase.

#### Damage Indicator

Damage can be a result of many different types of events. Examples include contact with objects (other cars, trees, traffic signs, road debris, etc), vandalism, or weather-related events. Not every damage event is reported to CARFAX. As details about the damage event become available, those additional details are added to the CARFAX Vehicle History Report. CARFAX recommends that you have this vehicle inspected by a qualified mechanic.

- This CARFAX Vehicle History Report is based only on information supplied to CARFAX and available as of 6/19/26 at 3:14:12 AM (CDT). Other information about this vehicle, including problems, may not have been reported to CARFAX. Use this report as one important tool, along with a vehicle inspection and test drive, to make a better decision about your next used car.

#### Damage Severity

Damage events result in one of the following severity levels:

- Minor: Generally, minor damage is cosmetic (including dents or scratches), may only require reconditioning, and typically does not compromise a vehicle's operation and/or safety.
- Moderate: Moderate damage may affect multiple components of the vehicle and may impair the vehicle's operation and/or safety.
- Severe: Severe damage usually affects multiple components of the vehicle and is likely to compromise the vehicle's operation and/or safety.

CARFAX recommends getting a pre-purchase inspection at a certified collision repair facility.

#### First Owner

When the first owner(s) obtains a title from a Department of Motor Vehicles as proof of ownership.

#### Ownership History

CARFAX defines an owner as an individual or business that possesses and uses a vehicle. Not all title transactions represent changes in ownership. To provide estimated number of owners, CARFAX proprietary technology analyzes all the events in a vehicle history. Estimated ownership is available for vehicles manufactured after 1991 and titled solely in the US including Puerto Rico. Dealers sometimes opt to take ownership of a vehicle and are required to in the following states: Maine, Massachusetts, New Jersey, Ohio, Oklahoma, Pennsylvania and South Dakota. Please consider this as you review a vehicle's estimated ownership history.

#### Salvage Title

A Salvage Title is issued on a vehicle damaged to the extent that the cost of repairing the vehicle exceeds approximately 75% of its pre-damage value. This damage threshold may vary by state. Some states treat Junk titles the same as Salvage but the majority use this title to indicate that a vehicle is not road worthy and cannot be titled again in that state. The following eleven states also use Salvage titles to identify stolen vehicles - AZ, FL, GA, IL, MD, MN, NJ, NM, NY, OK and OR.

#### Title Issued

A state issues a title to provide a vehicle owner with proof of ownership. Each title has a unique number. Each title or registration record on a CARFAX report does not necessarily indicate a change in ownership. In Canada, a registration and bill of sale are used as proof of ownership.

#### Total Loss Vehicle

An insurance or fleet company declares a vehicle a total loss when a claim exceeds approximately 75% of its pre-damage value or if the vehicle is stolen and not recovered. This damage threshold varies by company. These companies typically take possession and obtain the title. Not all total loss vehicles result in a DMV-reported branded title. This may occur when an insurance company's definition of a total loss is different than the state DMV's definition for a branded title or when the owner of the vehicle is a self-insured company, like a fleet or rental company.

Follow Us:



[facebook.com/CARFAX](https://facebook.com/CARFAX)



[@CARFAXinc](https://twitter.com/CARFAXinc)



[About CARFAX](#)

CARFAX DEPENDS ON ITS SOURCES FOR THE ACCURACY AND RELIABILITY OF ITS INFORMATION. THEREFORE, NO RESPONSIBILITY IS ASSUMED BY CARFAX OR ITS AGENTS FOR ERRORS OR OMISSIONS IN THIS REPORT. CARFAX FURTHER EXPRESSLY DISCLAIMS ALL WARRANTIES, EXPRESS OR IMPLIED, INCLUDING ANY IMPLIED WARRANTIES OF MERCHANTABILITY OR FITNESS FOR A PARTICULAR PURPOSE.

Customer Signature

Date

Dealer Signature

Date