





# Vehicle History Report™

US \$44.99

## 2019 BUICK ENCORE PREFERRED

VIN: KL4CJASB9KB779169  
4 DOOR WAGON/SPORT UTILITY  
1.4L I4 F DOHC 16V  
GASOLINE  
FRONT WHEEL DRIVE

 Branded Title: Salvage

 **24** Service history records

 **3** Previous owners

 Personal vehicle

 Last owned in Georgia

 **87,436** Last reported odometer reading

This CARFAX Vehicle History Report is based only on information supplied to CARFAX and available as of 7/18/25 at 7:37:47 AM (CDT). Other information about this vehicle, including problems, may not have been reported to CARFAX. Use this report as one important tool, along with a vehicle inspection and test drive, to make a better decision about your next used car.



## Accident / Damage History

Not all accidents / issues are reported to CARFAX

### Event 1

05/24/2021

#### Accident reported: minor damage

- Airbags did not deploy

#### Damage Severity Scale

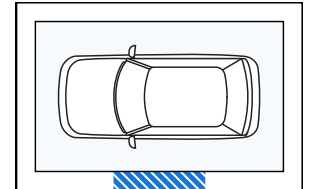
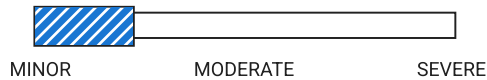

### Event 2

06/15/2022

#### Accident reported: minor damage

- Vehicle involved in a sideswipe collision  
- Airbags did not deploy

#### Damage Severity Scale

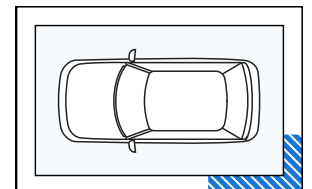
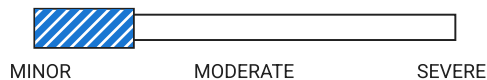

### Event 3

06/19/2022

**Accident reported: minor damage**

- Airbags did not deploy

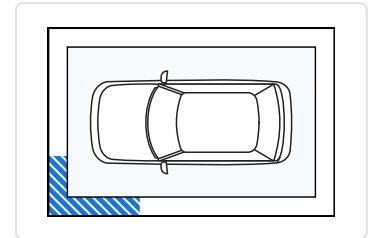
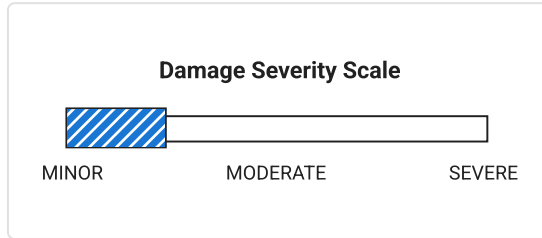

Event 4

05/15/2025

**Accident reported: moderate damage**

- Disabling damage reported  
- Airbags did not deploy

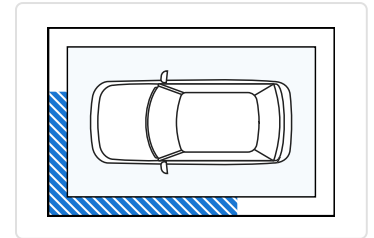
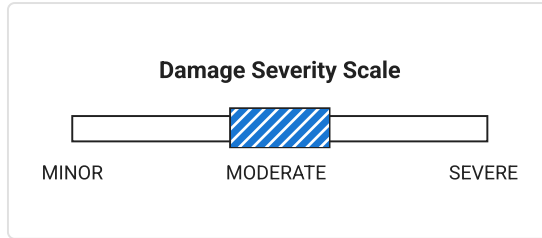

Event 5

05/15/2025

**TOTAL LOSS VEHICLE**

- Vehicle declared a total loss by an insurance company  
- Collision damage reported



**Recent Service Highlights**

Key services performed in the last 12 months

Service & Comments	Service	Comments	Date	View Details Links
Oil	<ul style="list-style-type: none"> <li>✓ Oil and filter changed</li> </ul>	<ul style="list-style-type: none"> <li>Oil</li> <li>✓ Oil and filter changed</li> </ul>	05/02/2025	05/02/25View > View Details >
Brakes	<ul style="list-style-type: none"> <li>✓ Brake pads replaced</li> <li>✓ Front brake pads replaced</li> <li>✓ Front brake rotor(s) replaced</li> </ul>	<ul style="list-style-type: none"> <li>Brakes</li> <li>✓ Brake pads replaced</li> <li>✓ Front brake pads replaced</li> <li>✓ Front brake rotor(s) replaced</li> </ul>	02/11/2025	02/11/25View > View Details >



This car has been recently serviced. That's a good thing!

 <b>Additional History</b> Not all accidents / issues are reported to CARFAX	Owner 1	Owner 2	Owner 3
<b>Total Loss</b> Total Loss Reported: 05/15/2025.	<input checked="" type="checkbox"/> No Issues Reported	Total Loss Reported	No New Issues Reported
<b>Structural Damage</b> CARFAX recommends that you have this vehicle inspected by a collision repair specialist.	<input checked="" type="checkbox"/> No Issues Reported	<input checked="" type="checkbox"/> No Issues Reported	<input checked="" type="checkbox"/> No Issues Reported
<b>Airbag Deployment</b> No airbag deployment reported to CARFAX.	<input checked="" type="checkbox"/> No Issues Reported	<input checked="" type="checkbox"/> No Issues Reported	<input checked="" type="checkbox"/> No Issues Reported
<b>Odometer Check</b> No indication of an odometer rollback.	<input checked="" type="checkbox"/> No Issues Indicated	<input checked="" type="checkbox"/> No Issues Indicated	<input checked="" type="checkbox"/> No Issues Indicated
<b>Accident / Damage</b> DMV title problems reported. Accidents reported: 05/24/2021, 06/15/2022, 06/19/2022, and 05/15/2025.	Accident Reported	Accident Reported	Severe Damage
<b>Manufacturer Recall</b> No open recalls reported to CARFAX. Check for open recalls on GM vehicles at recalls.gm.com.	<input checked="" type="checkbox"/> No Recalls Reported	<input checked="" type="checkbox"/> No Recalls Reported	<input checked="" type="checkbox"/> No Recalls Reported
<b>Basic Warranty</b> Original manufacturer warranty likely voided by manufacturer.	<input checked="" type="checkbox"/> Warranty Active	<input checked="" type="checkbox"/> Warranty Active	<b>Warranty Voided</b>

 <b>Title History</b>	Owner 1	Owner 2	Owner 3
<b>Damage Brands</b> Salvage   Junk   Rebuilt   Fire   Flood   Hail   Lemon	No Problem	No Problem	<b>Alert!</b> Problem Found
<b>Odometer Brands</b> Not Actual Mileage   Exceeds Mechanical Limits	No Problem	No Problem	No Problem



**ALERT!** - Severe problems were reported by a state Department of Motor Vehicles (DMV). This vehicle does not qualify for the CARFAX Buyback Guarantee.

 <b>Ownership History</b> The number of owners is estimated	Owner 1	Owner 2	Owner 3
Year purchased	2019	2024	2025
Type of owner	Personal	Personal	Personal
Estimated length of ownership	5 yrs. 4 mo.	11 months	17 days
Owned in the following states/provinces	Georgia	Georgia	Georgia
Estimated miles driven per year	14,421/yr	9,134/yr	---
Last reported odometer reading	77,128	87,436	---



## Detailed History







**Owner 1**

Purchased: 2019

Personal Vehicle

14,421 mi/yr

Date	Mileage	Source	Comments
02/26/2019		Georgia Motor Vehicle Dept.	<b>Vehicle purchase reported</b> - Titled or registered as personal vehicle
02/26/2019	72	Service Plan Co. Ellenwood, GA	<b>Service contract issued</b>
03/15/2019		Georgia Motor Vehicle Dept. Ellenwood, GA Title #775127190741965	<b>Vehicle purchase reported</b> - Title issued or updated - Title or registration issued - First owner reported - Loan or lien reported - Vehicle color noted as Gray
08/09/2019		Georgia Motor Vehicle Dept. Ellenwood, GA Title #775127190741965	<b>Registration issued or renewed</b> - Loan or lien reported - Vehicle color noted as Gray
09/13/2019	13,703	Hennessy GMC Buick Mazda Morrow, GA 770-968-6800 hennessycars.com ★ 4.6 / 5.0 677 Verified Reviews ❤️ 14,253 Customer Favorites	 <b>Vehicle serviced</b> - Maintenance inspection completed - Oil and filter changed - Tire condition and pressure checked
01/23/2020	22,029	Hennessy GMC Buick Mazda Morrow, GA 770-968-6800 hennessycars.com ★ 4.6 / 5.0 677 Verified Reviews ❤️ 14,253 Customer Favorites	 <b>Vehicle serviced</b> - Maintenance inspection completed - Oil and filter changed - Tires rotated
07/22/2020	29,867	Hennessy GMC Buick Mazda Morrow, GA 770-968-6800 hennessycars.com ★ 4.6 / 5.0 677 Verified Reviews ❤️ 14,253 Customer Favorites	 <b>Vehicle serviced</b> - Maintenance inspection completed - Oil and filter changed - Tires rotated
08/01/2020	30,615	Hennessy GMC Buick Mazda Morrow, GA 770-968-6800	 <b>Vehicle serviced</b> - Maintenance inspection completed - 15,000 mile service performed

hennescars.com

★ 4.6 / 5.0

677 Verified Reviews

♥ 14,253 Customer Favorites

08/07/2020

Georgia  
Motor Vehicle Dept.  
Locust Grove, GA  
Title #775127190741965

**Registration issued or renewed**

- Loan or lien reported
- Registration updated when owner moved the vehicle to a new location
- Vehicle color noted as Gray

12/03/2020 37,900

Hennesy GMC Buick  
Mazda  
Morrow, GA  
770-968-6800  
hennescars.com



**Vehicle serviced**

- Maintenance inspection completed
- Oil and filter changed
- Tires rotated

★ 4.6 / 5.0

677 Verified Reviews

♥ 14,253 Customer Favorites

05/24/2021

Damage Report



**Accident reported: minor damage**

- Damage to left side
- Airbags did not deploy



**CARFAX HAS THE MOST ACCIDENT & DAMAGE INFORMATION**

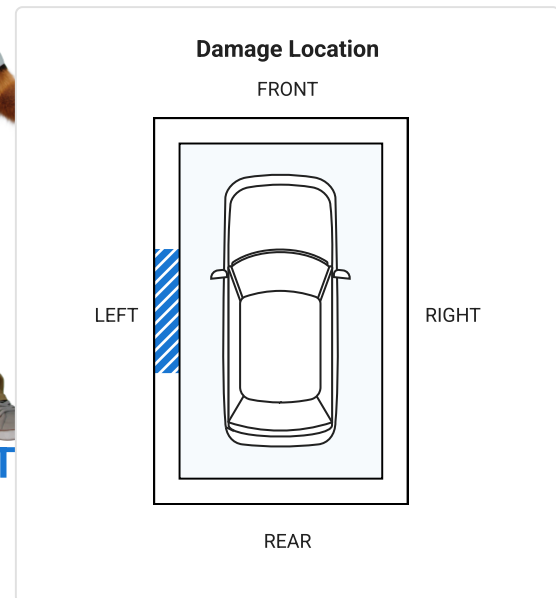
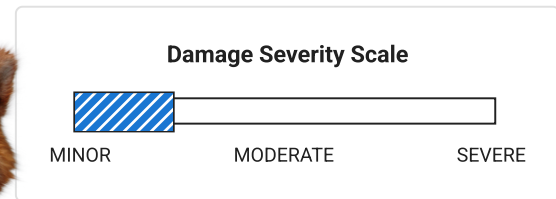

07/13/2021 46,001

McDonough Tire Center, Inc.  
Mcdonough, GA  
770-957-8833  
mcdonoughtire.com









**Vehicle serviced**

- Four wheel alignment performed

★ 5.0 / 5.0

267 Verified Reviews

♥ 380 Customer Favorites

07/19/2021		<p>Bellamy Strickland Mcdonough, GA 770-954-3000 bellamystrickland.com</p> <p>★ 4.6 / 5.0 1,491 Verified Reviews ❤️ 11,516 Customer Favorites</p>		<p><b>Vehicle serviced</b></p>
07/30/2021	46,255	<p>Precision Tune Auto Care Mcdonough, GA 770-302-0091 precisiontune.com</p> <p>★ 4.6 / 5.0 146 Verified Reviews ❤️ 2,170 Customer Favorites</p>		<p><b>Vehicle serviced</b></p> <ul style="list-style-type: none"> <li>- Air filter replaced</li> <li>- Oil and filter changed</li> <li>- Tires rotated</li> </ul>
07/30/2021		<p>Georgia Motor Vehicle Dept. Locust Grove, GA Title #775127190741965</p>		<p><b>Registration issued or renewed</b></p> <ul style="list-style-type: none"> <li>- Loan or lien reported</li> <li>- Vehicle color noted as Gray</li> </ul>
10/25/2021	49,606	<p>Brickyard Automotive Locust Grove, GA 678-379-2603 locustgrovega.brickyardautomotive.com/</p> <p>★ 4.8 / 5.0 184 Verified Reviews ❤️ 57 Customer Favorites</p>		<p><b>Vehicle serviced</b></p> <ul style="list-style-type: none"> <li>- Brakes checked</li> <li>- Tire(s) balanced</li> <li>- Tire(s) replaced</li> </ul>
12/16/2021	51,512	<p>Express Oil Change - Locust Grove Locust Grove, GA 770-898-3188 <a href="https://expressoil.com/stores/locust-grove/ga/1553/">https://expressoil.com/stores/locust-grove/ga/1553/</a></p> <p>★ 4.8 / 5.0 133 Verified Reviews ❤️ 3 Customer Favorites</p>		<p><b>Vehicle serviced</b></p> <ul style="list-style-type: none"> <li>- Maintenance inspection completed</li> <li>- Oil and filter changed</li> </ul>
04/29/2022	56,711	<p>Express Oil Change - Locust Grove Locust Grove, GA 770-898-3188 <a href="https://expressoil.com/stores/locust-grove/ga/1553/">https://expressoil.com/stores/locust-grove/ga/1553/</a></p> <p>★ 4.8 / 5.0 133 Verified Reviews ❤️ 3 Customer Favorites</p>		<p><b>Vehicle serviced</b></p> <ul style="list-style-type: none"> <li>- Maintenance inspection completed</li> <li>- Oil and filter changed</li> </ul>
06/15/2022		<p>Damage Report</p>		<p><b>Accident reported: minor damage</b></p> <ul style="list-style-type: none"> <li>- Vehicle involved in a sideswipe collision</li> <li>- Damage to left rear</li> <li>- Airbags did not deploy</li> </ul>



**CARFAX HAS THE MOST ACCIDENT & DAMAGE INFORMATION**

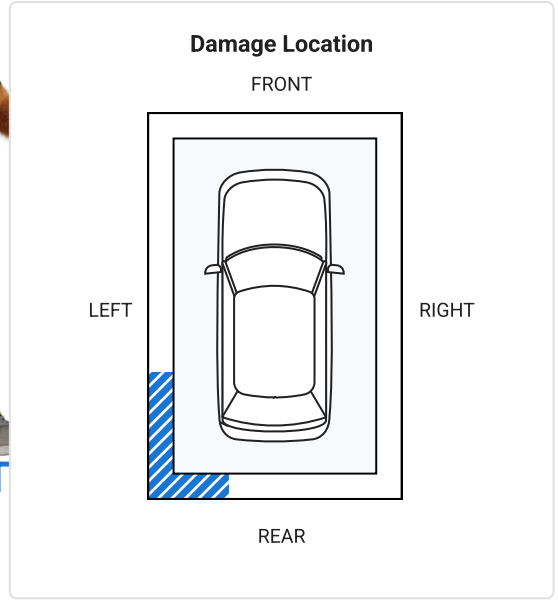
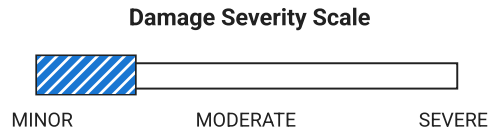

06/19/2022

Damage Report



**Accident reported: minor damage**

- Damage to left front
- Airbags did not deploy



**CARFAX HAS THE MOST ACCIDENT & DAMAGE INFORMATION**

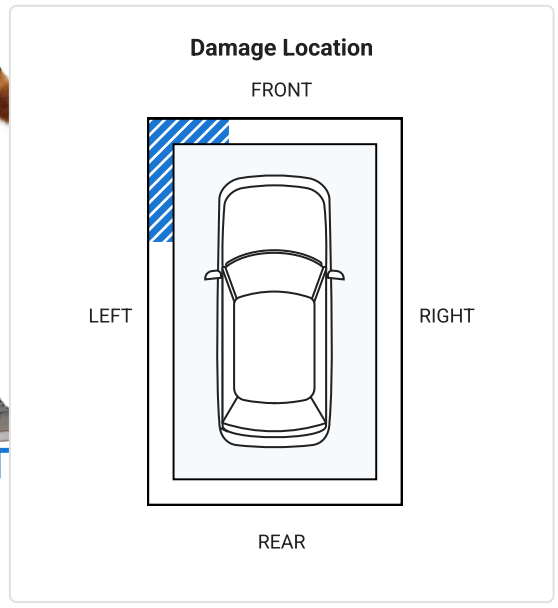
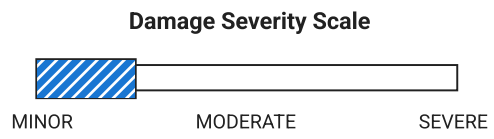

06/27/2022

59,388

Express Oil Change - Locust Grove  
 Locust Grove, GA  
 770-898-3188  
<https://expressoil.com/stores/locust-grove/ga/1553/>



**Vehicle serviced**

- Maintenance inspection completed
- Oil and filter changed

★ **4.8 / 5.0**  
133 Verified Reviews  
❤️ **3** Customer Favorites

08/12/2022 60,501

McDonough Tire Center, Inc.  
McDonough, GA  
770-957-8833  
mcdonoughtire.com



**Vehicle serviced**  
- Four wheel alignment performed  
- One tire replaced

★ **5.0 / 5.0**  
267 Verified Reviews  
❤️ **380** Customer Favorites

08/15/2022 60,629

Alpha Automotive Tire Pros  
- Locust Grove  
Locust Grove, GA  
678-379-2603



**Vehicle serviced**

★ **4.8 / 5.0**  
184 Verified Reviews  
❤️ **57** Customer Favorites

08/15/2022

Georgia  
Inspection Station

**Passed emissions inspection**

08/15/2022

Georgia  
Motor Vehicle Dept.  
Locust Grove, GA  
Title #775127190741965

**Registration issued or renewed**

- Loan or lien reported  
- Vehicle color noted as Gray

08/18/2022

Bellamy Strickland  
McDonough, GA  
770-954-3000  
bellamystrickland.com



**Vehicle serviced**

★ **4.6 / 5.0**  
1,491 Verified Reviews  
❤️ **11,516** Customer Favorites

03/04/2023 65,100

Express Oil Change - Locust  
Grove  
Locust Grove, GA  
770-898-3188  
<https://expressoil.com/stores/locust-grove/ga/1553/>



**Vehicle serviced**  
- Maintenance inspection completed  
- Oil and filter changed

★ **4.8 / 5.0**  
133 Verified Reviews  
❤️ **3** Customer Favorites

08/02/2023 69,758

Alpha Automotive Tire Pros  
- Locust Grove  
Locust Grove, GA  
678-379-2603



**Vehicle serviced**



★ **4.8 / 5.0**  
184 Verified Reviews  
❤️ **57** Customer Favorites

08/02/2023

Georgia



**Passed emissions inspection**

Inspection Station

08/02/2023		Georgia Motor Vehicle Dept. Locust Grove, GA Title #775127190741965		<b>Registration issued or renewed</b> - Loan or lien reported - Vehicle color noted as Gray
09/13/2023	70,607	Express Oil Change - Locust Grove Locust Grove, GA 770-898-3188 <a href="https://expressoil.com/stores/locust-grove/ga/1553/">https://expressoil.com/stores/locust-grove/ga/1553/</a> ★ 4.8 / 5.0 133 Verified Reviews ❤️ 3 Customer Favorites		<b>Vehicle serviced</b> - Maintenance inspection completed - Oil and filter changed
07/01/2024	77,128	Express Oil Change - Locust Grove Locust Grove, GA 770-898-3188 <a href="https://expressoil.com/stores/locust-grove/ga/1553/">https://expressoil.com/stores/locust-grove/ga/1553/</a> ★ 4.8 / 5.0 133 Verified Reviews ❤️ 3 Customer Favorites		<b>Vehicle serviced</b> - Maintenance inspection completed - Oil and filter changed

 **Owner 2**  
Purchased: 2024

Personal Vehicle  
9,134 mi/yr

Date	Mileage	Source		Comments
07/17/2024		Georgia Motor Vehicle Dept. Title #770201293306980		<b>Vehicle purchase reported</b> - Title issued or updated - New owner reported
08/05/2024	79,202	Alpha Automotive Tire Pros - Locust Grove Locust Grove, GA 678-379-2603 ★ 4.8 / 5.0 184 Verified Reviews ❤️ 57 Customer Favorites		<b>Vehicle serviced</b>
08/05/2024		Georgia Inspection Station		<b>Passed emissions inspection</b>
08/05/2024		Georgia Motor Vehicle Dept. Locust Grove, GA Title #770201293306980		<b>Registration issued or renewed</b> - Vehicle color noted as Gray
01/08/2025	83,198	Express Oil Change - Locust Grove Locust Grove, GA 770-898-3188		<b>Vehicle serviced</b> - Maintenance inspection completed - Oil and filter changed

<https://expressoil.com/stores/locust-grove/ga/1553/>

★ 4.8 / 5.0

133 Verified Reviews

♥ 3 Customer Favorites

02/11/2025 83,876

Alpha Automotive Tire Pros  
- Locust Grove  
Locust Grove, GA  
678-379-2603



**Vehicle serviced**

- Brakes checked
- Brake pads replaced
- Front brake pads replaced
- Front brake rotor(s) replaced

★ 4.8 / 5.0

184 Verified Reviews

♥ 57 Customer Favorites

05/02/2025 86,816

Express Oil Change - Locust Grove  
Locust Grove, GA  
770-898-3188  
<https://expressoil.com/stores/locust-grove/ga/1553/>



**Vehicle serviced**

- Maintenance inspection completed
- Oil and filter changed

★ 4.8 / 5.0

133 Verified Reviews

♥ 3 Customer Favorites

05/15/2025

Damage Report



**Accident reported: moderate damage**

- Damage to left front
- Damage to left side
- Damage to front
- Disabling damage reported
- Airbags did not deploy



**CARFAX HAS THE MOST ACCIDENT & DAMAGE INFORMATION**

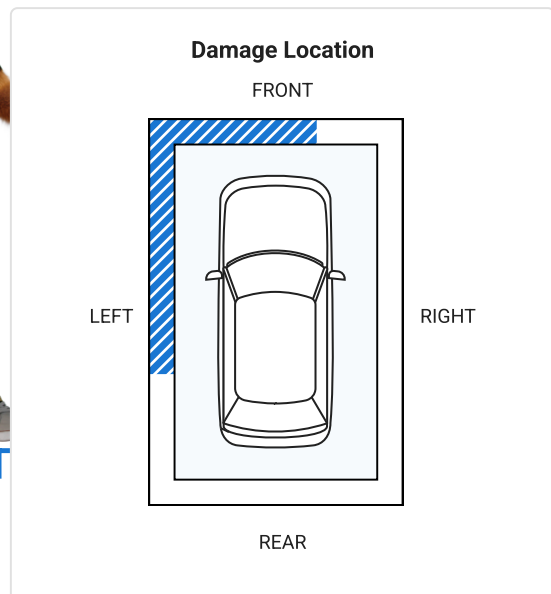
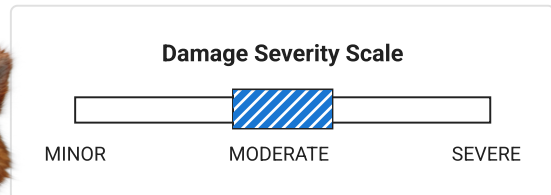

05/15/2025

Damage Report



**TOTAL LOSS VEHICLE**

- Vehicle declared a total loss by an insurance company
- Collision damage reported



There are many reasons an insurance company will declare a vehicle a total loss. Have this vehicle inspected by a qualified technician before you buy. [Learn More](#)

06/30/2025

87,436

Bellamy Strickland  
Mcdonough, GA  
770-954-3000  
bellamystrickland.com



**Vehicle serviced**

★ **4.6 / 5.0**  
1,491 Verified Reviews  
♥ **11,516** Customer Favorites



**Owner 3**

Purchased: 2025

Personal Vehicle

Date	Mileage	Source	Comments
07/01/2025		Georgia Motor Vehicle Dept.	<b>Vehicle purchase reported</b>
07/07/2025		Georgia Motor Vehicle Dept. Macon, GA Title #400240209438964	<b>New owner reported</b> <b>- SALVAGE TITLE/CERTIFICATE ISSUED</b> - Vehicle color noted as Gray
07/18/2025		OnStar	<b>Vehicle equipped with OnStar</b>  Get 3 free months of premium OnStar with Automatic Crash Response, Roadside Assistance and Remote Door Unlock by pressing the blue OnStar button <a href="#">Learn more</a>

Have Questions? Consumers, please visit our Help Center at [www.carfax.com](http://www.carfax.com). Dealers or Subscribers, please visit our Help Center at [www.carfaxonline.com](http://www.carfaxonline.com).



**Glossary**

**Accident Indicator**

CARFAX receives information about accidents in all 50 states, the District of Columbia and Canada.

Not every accident is reported to CARFAX. As details about the accident become available, those additional details are added to the CARFAX Vehicle History Report. CARFAX recommends that you have this vehicle inspected by a qualified mechanic.

- According to the National Safety Council, Injury Facts, 2021 edition, 5% of the 276 million registered vehicles in the U.S. were involved in an accident in 2019. Over 77% of these were considered minor or moderate.
- This CARFAX Vehicle History Report is based only on information supplied to CARFAX and available as of 7/18/25 at 7:37:47 AM (CDT). Other information about this vehicle, including problems, may not have been reported to CARFAX. Use this report as one important tool, along with a vehicle inspection and test drive, to make a better decision about your next used car.

**Damage Indicator**

Damage can be a result of many different types of events. Examples include contact with objects (other cars, trees, traffic signs, road debris, etc), vandalism, or weather-related events. Not every damage event is reported to CARFAX. As details about the damage event become available, those additional details are added to the CARFAX Vehicle History Report. CARFAX recommends that you have this vehicle inspected by a qualified mechanic.

- This CARFAX Vehicle History Report is based only on information supplied to CARFAX and available as of 7/18/25 at 7:37:47 AM (CDT). Other information about this vehicle, including problems, may not have been reported to CARFAX. Use this report as one important tool, along with a vehicle inspection and test drive, to make a better decision about your next used car.

### Damage Severity

Damage events result in one of the following severity levels:

- Minor: Generally, minor damage is cosmetic (including dents or scratches), may only require reconditioning, and typically does not compromise a vehicle's operation and/or safety.
- Moderate: Moderate damage may affect multiple components of the vehicle and may impair the vehicle's operation and/or safety.
- Severe: Severe damage usually affects multiple components of the vehicle and is likely to compromise the vehicle's operation and/or safety.

CARFAX recommends getting a pre-purchase inspection at a certified collision repair facility.

### First Owner

When the first owner(s) obtains a title from a Department of Motor Vehicles as proof of ownership.

### New Owner Reported

When a vehicle is sold to a new owner, the Title must be transferred to the new owner(s) at a Department of Motor Vehicles.

### Ownership History

CARFAX defines an owner as an individual or business that possesses and uses a vehicle. Not all title transactions represent changes in ownership. To provide estimated number of owners, CARFAX proprietary technology analyzes all the events in a vehicle history. Estimated ownership is available for vehicles manufactured after 1991 and titled solely in the US including Puerto Rico. Dealers sometimes opt to take ownership of a vehicle and are required to in the following states: Maine, Massachusetts, New Jersey, Ohio, Oklahoma, Pennsylvania and South Dakota. Please consider this as you review a vehicle's estimated ownership history.

### Salvage Title

A Salvage Title is issued on a vehicle damaged to the extent that the cost of repairing the vehicle exceeds approximately 75% of its pre-damage value. This damage threshold may vary by state. Some states treat Junk titles the same as Salvage but the majority use this title to indicate that a vehicle is not road worthy and cannot be titled again in that state. The following eleven states also use Salvage titles to identify stolen vehicles - AZ, FL, GA, IL, MD, MN, NJ, NM, NY, OK and OR.

### Title Issued

A state issues a title to provide a vehicle owner with proof of ownership. Each title has a unique number. Each title or registration record on a CARFAX report does not necessarily indicate a change in ownership. In Canada, a registration and bill of sale are used as proof of ownership.

### Total Loss Vehicle

An insurance or fleet company declares a vehicle a total loss when a claim exceeds approximately 75% of its pre-damage value or if the vehicle is stolen and not recovered. This damage threshold varies by company. These companies typically take possession and obtain the title. Not all total loss vehicles result in a DMV-reported branded title. This may occur when an insurance company's definition of a total loss is different than the state DMV's definition for a branded title or when the owner of the vehicle is a self-insured company, like a fleet or rental company.

Follow Us:  [facebook.com/CARFAX](https://facebook.com/CARFAX)  [@CARFAXinc](https://twitter.com/CARFAXinc)  [About CARFAX](#)

CARFAX DEPENDS ON ITS SOURCES FOR THE ACCURACY AND RELIABILITY OF ITS INFORMATION. THEREFORE, NO RESPONSIBILITY IS ASSUMED BY CARFAX OR ITS AGENTS FOR ERRORS OR OMISSIONS IN THIS REPORT. CARFAX FURTHER EXPRESSLY DISCLAIMS ALL WARRANTIES, EXPRESS OR IMPLIED, INCLUDING ANY IMPLIED WARRANTIES OF MERCHANTABILITY OR FITNESS FOR A PARTICULAR PURPOSE.

© 2025 CARFAX, Inc., part of S&P Global. All rights reserved.  
7/18/25 7:37:47 AM (CDT)

**I have reviewed and received a copy of the CARFAX Vehicle History Report for this 2019 BUICK ENCORE vehicle (VIN: KL4CJASB9KB779169), which is based on information supplied to CARFAX and available as of 7/18/25 at 8:37 AM (EDT).**

---

**Customer Signature**

**Date**

---

**Dealer Signature**

**Date**