



# Report

## 2016 Porsche Cayenne S E-Hybrid

123,288 mi | VIN: WP1AE2A28GLA64330

CARFAX HAS THE MOST ACCIDENT & DAMAGE INFORMATION



BRANDED TITLE

Salvage

19 Service History Records

2 Previous Owners

Types of Owners: Personal Lease, Personal

36 Detailed Records Available



## Accident / Damage History

Not all accidents / issues are reported to CARFAX

### Event 1

01/20/2019

#### Accident reported: minor damage

- Vehicle towed
- Airbags did not deploy

#### Damage Severity Scale

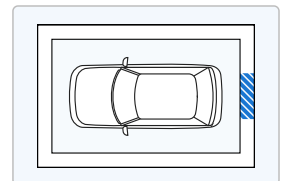
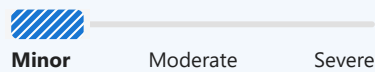

### Event 2

03/23/2023

#### TOTAL LOSS VEHICLE

- Accident reported
- Vehicle declared a total loss by an insurance company

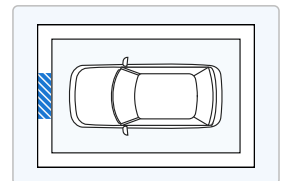

### Event 3

03/29/2023

**Damage reported: moderate damage**

-Airbag deployed

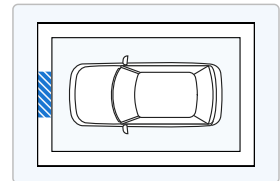
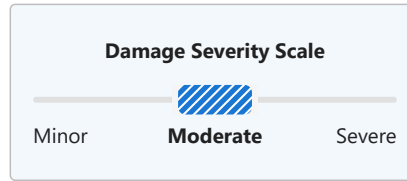

<b>CARFAX</b> Additional History Not all accidents / issues are reported to CARFAX	<b>Owner 1</b>	<b>Owner 2</b>
<b>Total Loss</b> Total Loss Reported: 03/23/2023 and 06/13/2023.	✔ No Issues Reported	Total Loss Reported
<b>Structural Damage</b> CARFAX recommends that you have this vehicle inspected by a collision repair specialist.	✔ No Issues Reported	✔ No Issues Reported
<b>Airbag Deployment</b> Airbag deployment reported: 03/29/2023.	✔ No Issues Reported	Airbag Deployment
<b>Odometer Check</b> No indication of an odometer rollback.	✔ No Issues Indicated	✔ No Issues Indicated
<b>Accident / Damage</b> DMV title problems reported. Accidents reported: 01/20/2019, 03/23/2023, and 06/13/2023. Damage reported: 03/29/2023.	✔ No Issues Reported	Severe Damage
<b>Manufacturer Recall</b> No open recalls reported to CARFAX.	✔ No Recalls Reported	✔ No Recalls Reported
<b>Basic Warranty</b> Original manufacturer warranty likely voided by manufacturer.	✔ Warranty Active	<b>Warranty Voided</b>

<b>CARFAX</b> Title History	<b>Owner 1</b>	<b>Owner 2</b>
<b>Damage Brands</b> Salvage   Junk   Rebuilt   Fire   Flood   Hail   Lemon	No Problem	<b>Alert!</b> Problem Found
<b>Odometer Brands</b> Not Actual Mileage   Exceeds Mechanical Limits	No Problem	No Problem



**ALERT!** - Severe problems were reported by a state Department of Motor Vehicles (DMV). This vehicle does not qualify for the CARFAX Buyback Guarantee.





<b>CARFAX</b> Ownership History The number of owners is estimated	<b>Owner 1</b>	<b>Owner 2</b>
Year purchased	2016	2019
Type of owner	Personal Lease	Personal
Estimated length of ownership	2 yrs. 5 mo.	4 yrs. 4 mo.
Owned in the following states/provinces	California	California
Estimated miles driven per year	7,922/yr	23,604/yr
Last reported odometer reading	19,729	123,288



**Detailed History**

 **Owner 1**  
Purchased: 2016



Personal Lease Vehicle  
7,922 mi/yr

Date	Mileage	Source	Comments
03/24/2016		Hoehn Porsche Carlsbad, CA 760-438-4434 hoehnporsche.com ★ <b>4.6 / 5.0</b> 123 Verified Reviews ♥ <b>79</b> Customer Favorites	<b>Vehicle offered for sale</b>
03/31/2016	19	Hoehn Porsche Carlsbad, CA 760-438-4434 hoehnporsche.com ★ <b>4.6 / 5.0</b> 123 Verified Reviews ♥ <b>79</b> Customer Favorites	 <b>Vehicle serviced</b> -Pre-delivery inspection completed
04/03/2016		Hoehn Acura Carlsbad, CA 760-438-9599 hoehnmotors.com ★ <b>4.6 / 5.0</b> 27 Verified Reviews	<b>Vehicle offered for sale</b>
05/27/2016	45	Hoehn Porsche Carlsbad, CA 760-438-4434 hoehnporsche.com ★ <b>4.6 / 5.0</b> 123 Verified Reviews ♥ <b>79</b> Customer Favorites	<b>Vehicle sold</b>
06/02/2016		California Motor Vehicle Dept. San Marcos, CA	<b>Title issued or updated</b> -First owner reported -Titled or registered as personal lease vehicle -Loan or lien reported
06/16/2016	307	Hoehn Porsche Carlsbad, CA 760-438-4434 hoehnporsche.com ★ <b>4.6 / 5.0</b> 123 Verified Reviews ♥ <b>79</b> Customer Favorites	 <b>Vehicle serviced</b>
04/13/2017		Hoehn Porsche Carlsbad, CA 760-438-4434 hoehnporsche.com ★ <b>4.6 / 5.0</b> 123 Verified Reviews ♥ <b>79</b> Customer Favorites	 <b>Vehicle serviced</b> -10,000 mile service performed -Electrical system checked -Tire condition and pressure checked -Vehicle washed/detailed
12/15/2017	9,425	Hoehn Porsche Carlsbad, CA 760-438-4434 hoehnporsche.com ★ <b>4.6 / 5.0</b> 123 Verified Reviews ♥ <b>79</b> Customer Favorites	 <b>Vehicle serviced</b> -Computer reprogrammed
10/04/2018	18,100	Hoehn Porsche Carlsbad, CA 760-438-4434	 <b>Vehicle serviced</b> -10,000 mile service performed -Tire condition and pressure checked

hoehnporsche.com

★ 4.6 / 5.0 123 Verified Reviews

♥ 79 Customer Favorites

11/27/2018	19,709	Hoehn Porsche Carlsbad, CA 760-438-4434 hoehnporsche.com ★ 4.6 / 5.0 123 Verified Reviews ♥ 79 Customer Favorites	<b>Vehicle offered for sale</b>
11/28/2018	19,711	Carlsbad Buick GMC Cadillac Carlsbad, CA 760-891-2777 cadillaccarlsbad.com ★ 4.8 / 5.0 36 Verified Reviews	 <b>Vehicle serviced</b> -Four tires balanced -Four tires mounted -Tire condition and pressure checked
11/30/2018	19,723	Hoehn Porsche Carlsbad, CA 760-438-4434 hoehnporsche.com ★ 4.6 / 5.0 123 Verified Reviews ♥ 79 Customer Favorites	 <b>Vehicle serviced</b>
12/15/2018	19,729	Hoehn Porsche Carlsbad, CA 760-438-4434 hoehnporsche.com ★ 4.6 / 5.0 123 Verified Reviews ♥ 79 Customer Favorites	<b>Vehicle sold</b>

 **Owner 2**  
Purchased: 2019

Personal Vehicle  
23,604 mi/yr

Date	Mileage	Source	Comments
01/04/2019		California Motor Vehicle Dept. Murrieta, CA	<b>Title issued or updated</b> -New owner reported
01/20/2019		Damage Report	<b>Accident reported: minor damage</b> -Damage to rear -Vehicle towed -Airbags did not deploy



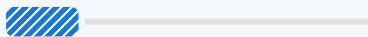



**Damage Severity Scale**



**Minor**
Moderate
Severe

**CARFAX HAS THE MOST  
ACCIDENT & DAMAGE  
INFORMATION**



05/08/2019	27,319	<p>Hoehn Porsche Carlsbad, CA 760-438-4434 hoehnporsche.com</p> <p>★ <b>4.6 / 5.0</b> 123 Verified Reviews ♥ <b>79</b> Customer Favorites</p>	 <p><b>Vehicle serviced</b> -Blind spot warning checked -Lane departure warning checked -Tire condition and pressure checked</p>
06/05/2019	29,370	<p>Hoehn Porsche Carlsbad, CA 760-438-4434 hoehnporsche.com</p> <p>★ <b>4.6 / 5.0</b> 123 Verified Reviews ♥ <b>79</b> Customer Favorites</p>	 <p><b>Vehicle serviced</b> -Maintenance inspection completed -Recommended maintenance performed -30,000 mile service performed -Tire condition and pressure checked</p>
11/27/2019	39,988	<p>Hoehn Porsche Carlsbad, CA 760-438-4434 hoehnporsche.com</p> <p>★ <b>4.6 / 5.0</b> 123 Verified Reviews ♥ <b>79</b> Customer Favorites</p>	 <p><b>Vehicle serviced</b> -Fuel system cleaned/serviced -Spark plug(s) replaced</p>
01/17/2020	43,666	<p>Walmart Auto Care Center Murrieta, CA 951-461-1781 <a href="https://www.walmart.com">https://www.walmart.com</a></p> <p>★ <b>4.5 / 5.0</b> 188 Verified Reviews ♥ <b>3</b> Customer Favorites</p>	 <p><b>Vehicle serviced</b> -Tire(s) balanced</p>
07/06/2020	53,449	<p>Porsche San Diego San Diego, CA 858-695-3000 <a href="https://porschesandiego.com">https://porschesandiego.com</a></p> <p>★ <b>4.8 / 5.0</b> 152 Verified Reviews ♥ <b>85</b> Customer Favorites</p>	 <p><b>Vehicle serviced</b> -Maintenance inspection completed -10,000 mile service performed -Oil and filter changed -Tire condition and pressure checked -Vehicle washed/detailed</p>
10/26/2020	61,715	<p>Porsche San Diego San Diego, CA 858-695-3000 <a href="https://porschesandiego.com">https://porschesandiego.com</a></p> <p>★ <b>4.8 / 5.0</b> 152 Verified Reviews ♥ <b>85</b> Customer Favorites</p>	 <p><b>Vehicle serviced</b> -Maintenance inspection completed -Oil and filter changed</p>
03/23/2021	74,367	<p>Walmart Auto Care Center Murrieta, CA 951-461-1781 <a href="https://www.walmart.com">https://www.walmart.com</a></p>	 <p><b>Vehicle serviced</b> -Tire repaired</p>

★ **4.5 / 5.0** 188 Verified Reviews  
♥ **3** Customer Favorites

04/02/2021 75,395

Walmart Auto Care Center  
Murrieta, CA  
951-461-1781  
<https://www.walmart.com>



**Vehicle serviced**

- Tire(s) balanced
- Tires rotated

★ **4.5 / 5.0** 188 Verified Reviews  
♥ **3** Customer Favorites

04/26/2021 76,203

Porsche San Diego  
San Diego, CA  
858-695-3000  
<https://porschesandiego.com>



**Vehicle serviced**

- Maintenance inspection completed
- Oil and filter changed
- Serpentine belt replaced
- Spark plug(s) replaced

★ **4.8 / 5.0** 152 Verified Reviews  
♥ **85** Customer Favorites

01/27/2022 99,907

Porsche San Diego  
San Diego, CA  
858-695-3000  
<https://porschesandiego.com>



**Vehicle serviced**

- Maintenance inspection completed
- Brake fluid flushed/changed
- Oil and filter changed
- Tire condition and pressure checked
- Tires rotated

★ **4.8 / 5.0** 152 Verified Reviews  
♥ **85** Customer Favorites

07/06/2022 113,259

Porsche San Diego  
San Diego, CA  
858-695-3000  
<https://porschesandiego.com>



**Vehicle serviced**

- Maintenance inspection completed
- Blower motor replaced/repaired
- Brakes checked
- Front brake rotor(s) replaced
- Oil and filter changed
- Oxygen sensor replaced

★ **4.8 / 5.0** 152 Verified Reviews  
♥ **85** Customer Favorites

09/06/2022

Porsche Cars North America

**Manufacturer Voluntary Service Action issued**

-Program #WMP4 RETROFIT CHARGING CABLE LABEL

Click here or call 1-800-PORSCHE to locate an authorized Porsche dealer near you.

🔗 **Learn more about this campaign**

11/30/2022 115,622

Porsche San Diego  
San Diego, CA  
858-695-3000  
<https://porschesandiego.com>



**Vehicle serviced**

- Oil and filter changed
- Serpentine belt replaced
- Spark plug(s) replaced

★ **4.8 / 5.0** 152 Verified Reviews  
♥ **85** Customer Favorites

03/23/2023

Damage Report



**TOTAL LOSS VEHICLE**

- Accident reported
- Vehicle declared a total loss by an insurance company
- Damage to front

**CARFAX HAS THE MOST  
ACCIDENT & DAMAGE  
INFORMATION**

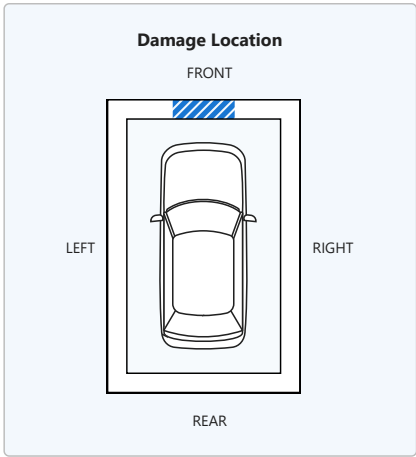

There are many reasons an insurance company will declare a vehicle a total loss. Have this vehicle inspected by a qualified technician before you buy. [Learn More](#)

03/29/2023

Damage Report



**Damage reported: moderate damage**

- Damage to front
- Airbag deployed
- CARFAX Airbag Tips

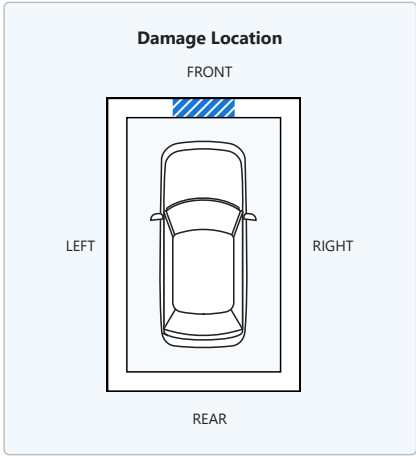
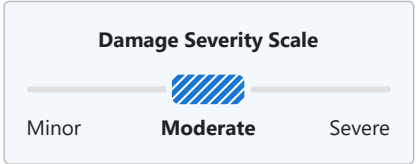

**CARFAX HAS THE MOST ACCIDENT & DAMAGE INFORMATION**

04/13/2023

California  
Motor Vehicle Dept.  
Murrieta, CA

**Title issued or updated**

- Duplicate title issued

05/31/2023

123,288

California  
Motor Vehicle Dept.  
Rancho Cordova, CA

**Odometer reading reported**

06/02/2023

California  
Motor Vehicle Dept.

**Title or registration issued to insurance company**

06/02/2023

California  
Motor Vehicle Dept.  
Rancho Cordova, CA



**Dealer took title of this vehicle while it was in inventory**

- SALVAGE TITLE/CERTIFICATE ISSUED**

06/13/2023

Damage Report



**TOTAL LOSS VEHICLE**

- Vehicle declared a total loss by an insurance company
- Collision damage reported

07/19/2023

Vehicle Exporter

**Vehicle exported from**

-Los Angeles, CA and imported to  
-Poti, Georgia

Have Questions? Consumers, please visit our Help Center at [www.carfax.com](http://www.carfax.com). Dealers or Subscribers, please visit our Help Center at [www.carfaxonline.com](http://www.carfaxonline.com).



## Glossary

### Accident Indicator

CARFAX receives information about accidents in all 50 states, the District of Columbia and Canada.

Not every accident is reported to CARFAX. As details about the accident become available, those additional details are added to the CARFAX Vehicle History Report. CARFAX recommends that you have this vehicle inspected by a qualified mechanic.

### Airbag Deployment

Occurs when the driver, passenger or side airbag has been used or deployed during a crash or other incident. If an airbag has been deployed, it must be replaced by a qualified technician. Have this car inspected by a mechanic prior to purchase.

### Damage Indicator

Damage can be a result of many different types of events. Examples include contact with objects (other cars, trees, traffic signs, road debris, etc), vandalism, or weather-related events. Not every damage event is reported to CARFAX. As details about the damage event become available, those additional details are added to the CARFAX Vehicle History Report. CARFAX recommends that you have this vehicle inspected by a qualified mechanic.

- This CARFAX Vehicle History Report is based only on information supplied to CARFAX and available as of 6/20/26 at 2:33:25 AM (CDT). Other information about this vehicle, including problems, may not have been reported to CARFAX. Use this report as one important tool, along with a vehicle inspection and test drive, to make a better decision about your next used car.

### Damage Severity

Damage events result in one of the following severity levels:

- Minor: Generally, minor damage is cosmetic (including dents or scratches), may only require reconditioning, and typically does not compromise a vehicle's operation and/or safety.
- Moderate: Moderate damage may affect multiple components of the vehicle and may impair the vehicle's operation and/or safety.
- Severe: Severe damage usually affects multiple components of the vehicle and is likely to compromise the vehicle's operation and/or safety.

CARFAX recommends getting a pre-purchase inspection at a certified collision repair facility.

### First Owner

When the first owner(s) obtains a title from a Department of Motor Vehicles as proof of ownership.

### New Owner Reported

When a vehicle is sold to a new owner, the Title must be transferred to the new owner(s) at a Department of Motor Vehicles.

### Ownership History

CARFAX defines an owner as an individual or business that possesses and uses a vehicle. Not all title transactions represent changes in ownership. To provide estimated number of owners, CARFAX proprietary technology analyzes all the events in a vehicle history. Estimated ownership is available for vehicles manufactured after 1991 and titled solely in the US including Puerto Rico. Dealers sometimes opt to take ownership of a vehicle and are required to in the following states: Maine, Massachusetts, New Jersey, Ohio, Oklahoma, Pennsylvania and South Dakota. Please consider this as you review a vehicle's estimated ownership history.

### Salvage Title

A Salvage Title is issued on a vehicle damaged to the extent that the cost of repairing the vehicle exceeds approximately 75% of its pre-damage value. This damage threshold may vary by state. Some states treat Junk titles the same as Salvage but the majority use this title to indicate that a vehicle is not road worthy and cannot be titled again in that state. The following eleven states also use Salvage titles to identify stolen vehicles - AZ, FL, GA, IL, MD, MN, NJ, NM, NY, OK and OR.

### Service Campaign

Automobile manufacturers issue a service campaign to address product technical issues that may not be related to safety or emissions standards. These issues are typically customer satisfaction initiatives.

### Title Issued

A state issues a title to provide a vehicle owner with proof of ownership. Each title has a unique number. Each title or registration record on a CARFAX report does not necessarily indicate a change in ownership. In Canada, a registration and bill of sale are used as proof of ownership.

### Total Loss Vehicle

An insurance or fleet company declares a vehicle a total loss when a claim exceeds approximately 75% of its pre-damage value or if the vehicle is stolen and not recovered. This damage threshold varies by company. These companies typically take possession and obtain the title. Not all total loss vehicles result in a DMV-reported branded title. This may occur when an insurance company's definition of a total loss is different than the state DMV's definition for a branded title or when the owner of the vehicle is a self-insured company, like a fleet or rental company.

Follow Us:



[facebook.com/CARFAX](https://www.facebook.com/CARFAX)



[@CARFAXinc](https://twitter.com/CARFAXinc)



[About CARFAX](#)

CARFAX DEPENDS ON ITS SOURCES FOR THE ACCURACY AND RELIABILITY OF ITS INFORMATION. THEREFORE, NO RESPONSIBILITY IS ASSUMED BY CARFAX OR ITS AGENTS FOR ERRORS OR OMISSIONS IN THIS REPORT. CARFAX FURTHER EXPRESSLY DISCLAIMS ALL WARRANTIES, EXPRESS OR IMPLIED, INCLUDING ANY IMPLIED WARRANTIES OF MERCHANTABILITY OR FITNESS FOR A PARTICULAR PURPOSE.

Customer Signature

Date

Dealer Signature

Date

